

2C351 – Sealing Head Light Series – Metric Swivel Nut

51 Series

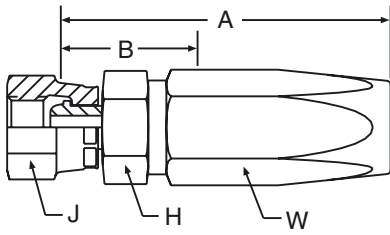

Part No. #	DN size mm inch				Connection Type Thread Size	A mm	B mm	H mm	J mm	W mm
	mm	inch	mm	inch						
2C351-6-3	5	-03	4.8	3/16	M12 x 1.5	43	24	–	14	17
2C351-8-4	6	-04	6.4	1/4	M14 x 1.5	47	25	–	19	17
2C351-10-5	8	-05	7.9	5/16	M16 x 1.5	48	22	–	19	22
2C351-10-6	10	-06	9.5	3/8	M16 x 1.5	63	35	17	19	22
2C351-12-6	10	-06	9.5	3/8	M18 x 1.5	63	34	19	22	22
2C351-15-8	12	-08	12.7	1/2	M22 x 1.5	74	41	22	27	27
2C351-18-12	20	-12	19.0	3/4	M26 x 1.5	78	37	27	32	36
2C351-22-12	20	-12	19.0	3/4	M30 x 2	82	41	30	36	36
2C351-28-16	25	-16	25.4	1	M36 x 2	98	52	36	46	43

Material: Steel, surface protection according to DIN 50 961 Fe/Zn, special materials available upon request

2C451 – Sealing Head 45° Elbow Light Series – Metric Swivel Nut

51 Series

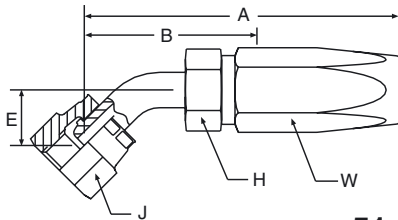

Part No. #	DN size mm inch				Connection Type Thread Size	A mm	B mm	E mm	H mm	J mm	W mm
	mm	inch	mm	inch							
2C451-6-3	5	-03	4.8	3/16	M12 x 1.5	60	32	13	14	17	17
2C451-8-4	6	-04	6.4	1/4	M14 x 1.5	59	40	13	14	19	17
2C451-10-5	8	-05	7.9	5/16	M16 x 1.5	70	41	16	17	19	22
2C451-10-6	10	-06	9.5	3/8	M16 x 1.5	83	56	18	17	19	22
2C451-12-6	10	-06	9.5	3/8	M18 x 1.5	89	58	19	17	22	22
2C451-15-8	12	-08	12.7	1/2	M22 x 1.5	100	64	21	19	27	27
2C451-18-12	20	-12	19.0	3/4	M26 x 1.5	116	75	26	27	36	36
2C451-22-12	20	-12	19.0	3/4	M30 x 2	119	79	29	27	36	36
2C451-28-16	25	-16	25.4	1	M36 x 2	127	82	31	32	46	43

Material: Steel, surface protection according to DIN 50 961 Fe/Zn, special materials available upon request

2C551 – Sealing Head 90° Elbow Light Series – Metric Swivel Nut

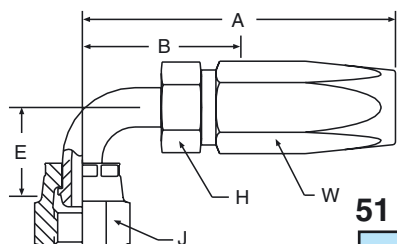

51 Series

Part No. #	DN size mm inch				Connection Type Thread Size	A mm	B mm	E mm	H mm	J mm	W mm
	mm	inch	mm	inch							
2C551-6-3	5	-03	4.8	3/16	M12 x 1.5	55	33	36	14	17	16
2C551-8-4	6	-04	6.4	1/4	M14 x 1.5	53	34	25	14	17	17
2C551-10-5	8	-05	7.9	5/16	M16 x 1.5	66	40	32	17	19	19
2C551-10-6	10	-06	9.5	3/8	M16 x 1.5	75	47	35	17	19	22
2C551-12-6	10	-06	9.5	3/8	M18 x 1.5	80	49	36	17	22	22
2C551-15-8	12	-08	12.7	1/2	M22 x 1.5	89	53	42	22	27	27
2C551-18-12	20	-12	19.0	3/4	M26 x 1.5	70	70	59	27	36	35
2C551-22-12	20	-12	19.0	3/4	M30 x 2	73	73	64	30	36	35
2C551-28-16	25	-16	25.4	1	M36 x 2	75	75	67	32	46	43

Material: Steel, surface protection according to DIN 50 961 Fe/Zn, special materials available upon request

2D051 – Metric Male 24° Cone Light Series ISO 12151-2

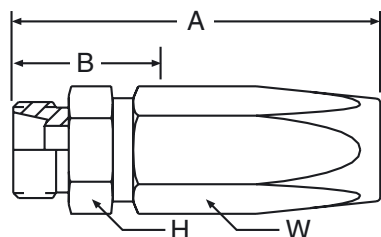

51 Series

Part No. #	DN size mm inch				Connection Type Thread Size	A mm	B mm	H mm	W mm
	mm	inch	mm	inch					
2D051-6-3	5	-03	4.8	3/16	M12 x 1.5	43	24	14	16
2D051-8-4	6	-04	6.4	1/4	M14 x 1.5	46	25	17	17
2D051-10-5	8	-05	7.9	5/16	M16 x 1.5	52	26	17	19
2D051-10-6	10	-06	9.5	3/8	M16 x 1.5	59	30	17	22
2D051-12-6	10	-06	9.5	3/8	M18 x 1.5	59	30	19	22
2D051-15-8	12	-08	12.7	1/2	M22 x 1.5	66	34	22	27
2D051-18-12	20	-12	19.0	3/4	M26 x 1.5	72	32	27	35
2D051-22-12	20	-12	19.0	3/4	M30 x 1.5	75	35	30	35
2D051-28-16	25	-16	25.4	1	M36 x 2	84	38	36	43

Material: Steel, surface protection according to DIN 50 961 Fe/Zn, special materials available upon request

21D51 – Metric Standpipe Light Series

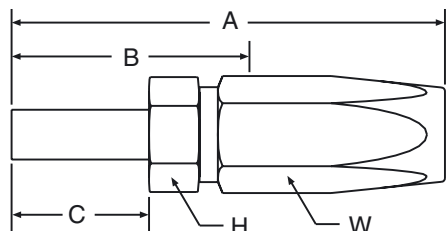

51 Series

Part No. #	DN size mm inch				A mm	B mm	C mm	H mm	W mm
	mm	inch	mm	inch					
21D51-6-3	5	-03	4.8	3/16	55	35	22	14	16
21D51-6-6	10	-06	9.5	3/8	67	32	18	19	22
21D51-8-4	6	-04	6.4	1/4	58	36	22	14	17
21D51-10-5	8	-05	7.9	5/16	64	38	23	14	19
21D51-10-6	10	-06	9.5	3/8	71	42	23	17	22
21D51-12-6	10	-06	9.5	3/8	71	42	23	17	22
21D51-15-8	12	-08	12.7	1/2	80	48	25	19	27
21D51-18-12	20	-12	19.0	3/4	86	46	26	27	35
21D51-22-12	20	-12	19.0	3/4	88	48	28	27	35
21D51-28-16	25	-16	25.4	1	104	58	30	32	43

Material: Steel, surface protection according to DIN 50 961 Fe/Zn, special materials available upon request

2C651 – Sealing Head Heavy Series Metric Swivel Nut

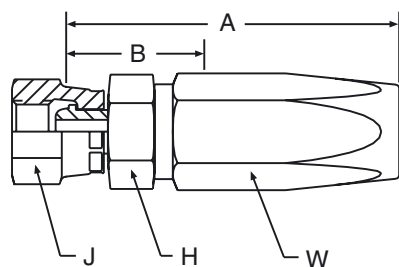

51 Series

Part No. #	DN size mm inch				Connection Type Thread Size	A mm	B mm	H mm	J mm	W mm
	mm	inch	mm	inch						
2C651-6-3	5	-03	4,8	3/16	M16 x 1,5	49	28	17	19	16
2C651-10-4	6	-04	6,4	1/4	M18 x 1,5	61	36	17	22	17
2C651-12-5	8	-05	7,9	5/16	M20 x 1,5	61	35	19	24	19
2C651-12-6	10	-06	9,5	3/8	M20 x 1,5	64	36	19	24	22
2C651-14-6	10	-06	9,5	3/8	M22 x 1,5	65	37	22	27	22
2C651-16-8	12	-08	12,7	1/2	M24 x 1,5	73	40	24	30	27
2C651-20-12	20	-12	19,0	3/4	M30 x 2	81	41	30	36	35
2C651-25-12	20	-12	19,0	3/4	M36 x 2	81	40	36	46	35
2C651-30-16	25	-16	25,4	1	M42 x 2	94	48	41	50	43

Material: Steel, surface protection according to DIN 50 961 Fe/Zn, special materials available upon request

2D251 – Metric Male 24° Cone Heavy Series ISO 12151-2

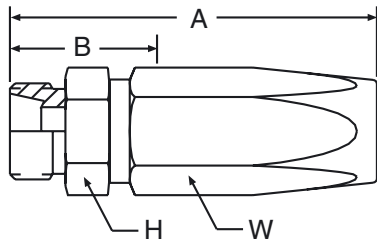

51 Series

Part No. #	DN size mm inch				Connection Type Thread Size	A mm	B mm	H mm	W mm
	mm	inch	mm	inch					
2D251-8-3	5	-03	4.8	3/16	M16 x 1.5	47	27	17	16
2D251-10-4	6	-04	6.4	1/4	M18 x 1.5	53	28	19	17
2D251-12-5	8	-05	7.9	5/16	M20 x 1.5	55	27	22	19
2D251-12-6	10	-06	9.5	3/8	M20 x 1.5	63	34	22	22
2D251-14-6	10	-06	9.5	3/8	M22 x 1.5	64	35	22	22
2D251-16-8	12	-08	12.7	1/2	M24 x 1.5	72	40	24	27
2D251-20-12	20	-12	19.0	3/4	M30 x 2	80	40	30	35
2D251-25-12	20	-12	19.0	3/4	M36 x 2	84	44	36	35
2D251-30-16	25	-16	25.4	1	M42 x 2	96	50	46	43

Material: Steel, surface protection according to DIN 50 961 Fe/Zn, special materials available upon request

23D51 – Metric Standpipe Heavy Series

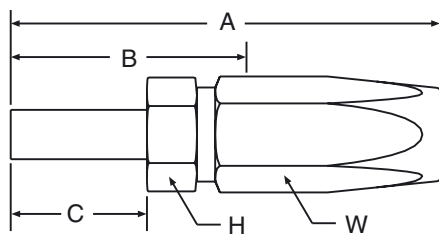

51 Series

Part No. #	DN size mm inch				A mm	B mm	C mm	H mm	W mm
	mm	inch	mm	inch					
23D51-8-3	5	-03	4.8	3/16	56	36	24	14	16
23D51-10-4	6	-04	6.4	1/4	58	36	26	14	17
23D51-12-5	8	-05	7.9	5/16	65	39	26	14	19
23D51-12-6	10	-06	9.5	3/8	74	46	26	17	22
23D51-14-6	10	-06	9.5	3/8	77	48	29	17	22
23D51-16-8	12	-08	12.7	1/2	84	52	30	19	27
23D51-20-12	20	-12	19.0	3/4	99	58	36	27	35
23D51-25-12	20	-12	19.0	3/4	106	65	40	27	35
23D51-30-16	25	-16	25.4	1	118	72	44	32	43

Material: Steel, surface protection according to DIN 50 961 Fe/Zn, special materials available upon request



29251 – Sealing Head (60°) BSP Swivel Nut

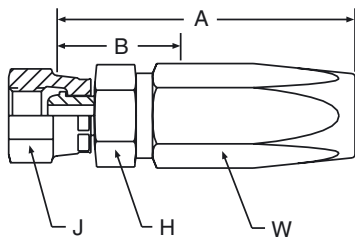

51 Series

Part No. #	DN size		mm		inch		Connection Type Thread Size	A mm	B mm	H mm	J mm	W mm
29251-4-3	5	-03	4.8	3/16	G 1/4	45	25	–	19	17		
29251-4-4	6	-04	6.4	1/4	G 1/4	47	28	–	17	17		
29251-6-5	8	-05	7.9	5/16	G 3/8	48	24	–	22	22		
29251-6-6	10	-06	9.5	3/8	G 3/8	63	35	17	22	22		
29251-8-8	12	-08	12.7	1/2	G 1/2	74	41	22	27	27		
29251-10-8	12	-08	12.7	1/2	G 5/8	73	40	24	30	27		
29251-12-12	20	-12	19.0	3/4	G 3/4	78	37	27	32	36		

Material: Steel, surface protection according to DIN 50 961 Fe/Zn, special materials available upon request

2B151 – Sealing Head (60°) 45° Elbow BSP Swivel Nut

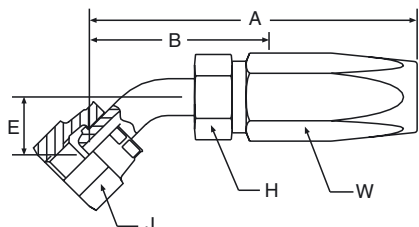

51 Series

Part No. #	DN size		mm		inch		Connection Type Thread Size	A mm	B mm	E mm	H mm	J mm	W mm
2B151-4-3	5	-03	4.8	3/16	G 1/4	58	38	14	14	17	16		
2B151-4-4	6	-04	6.4	1/4	G 1/4	59	40	14	14	17	17		
2B151-6-5	8	-05	7.9	5/16	G 3/8	70	44	14	14	19	19		
2B151-6-6	10	-06	9.5	3/8	G 3/8	80	49	16	17	19	22		
2B151-8-8	12	-08	12.7	1/2	G 1/2	95	59	18	22	27	27		
2B151-12-12	20	-12	19.0	3/4	G 3/4	100	60	20	30	32	35		
2B151-16-16	25	-16	25.4	1	G 1	122	76	26	32	41	43		

Material: Steel, surface protection according to DIN 50 961 Fe/Zn, special materials available upon request

2B251 – Sealing Head (60°) 90° Elbow BSP Swivel Nut

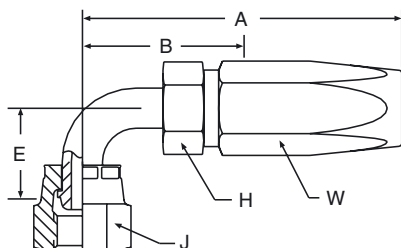

51 Series

Part No. #	DN size		mm		inch		Connection Type	A	B	E	H	J	W
	mm	inch	mm	inch	Thread Size	mm	mm	mm	mm	mm	mm	mm	
2B251-4-3	5	-03	4.8	3/16	G 1/4	58	33	14	14	17	16		
2B251-4-4	6	-04	6.4	1/4	G 1/4	59	33	26	14	17	17		
2B251-6-5	8	-05	7.9	5/16	G 3/8	66	40	34	14	19	19		
2B251-6-6	10	-06	9.5	3/8	G 3/8	75	44	31	17	19	22		
2B251-8-8	12	-08	12.7	1/2	G 1/2	89	53	38	22	27	27		
2B251-12-12	20	-12	19.0	3/4	G 3/4	104	64	47	30	32	35		
2B251-16-16	25	-16	25.4	1	G 1	120	74	62	32	41	43		

Material: Steel, surface protection according to DIN 50 961 Fe/Zn, special materials available upon request

2D951 – BSP Male DIN 3852 Shape A

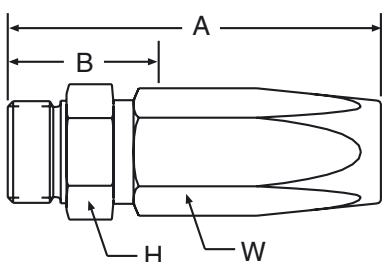

51 Series

Part No. #	DN size		mm		inch		Connection Type	A	B	H	W
	mm	inch	mm	inch	Thread Size	mm	mm	mm	mm	mm	
2D951-2-3	5	-03	4.8	3/16	G 1/8	44	24	14	16		
2D951-4-3	5	-03	4.8	3/16	G 1/4	49	29	19	16		
2D951-4-4	6	-04	6.4	1/4	G 1/4	54	29	19	17		
2D951-6-5	8	-05	7.9	5/16	G 3/8	58	30	22	19		
2D951-6-6	10	-06	9.5	3/8	G 3/8	62	34	22	22		
2D951-8-8	12	-08	12.7	1/2	G 1/2	73	41	27	27		
2D951-12-12	20	-12	19.0	3/4	G 3/4	81	41	32	35		
2D951-16-16	25	-16	25.4	1	G 1	95	49	41	43		

Material: Steel, surface protection according to DIN 50 961 Fe/Zn, special materials available upon request

20151 – NPTF Male - 60° Cone

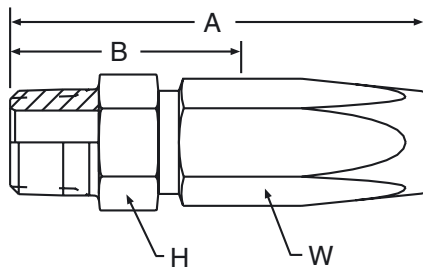

51 Series

Part No. #	DN size mm inch				Connection Type		A mm	B mm	H mm	W mm
					Thread Size					
20151-2-3	5	-03	4.8	3/16	1/8 - 27NPTF		43	25	11	17
20151-4-3	5	-03	4.8	3/16	1/4 - 18NPTF		48	29	14	17
20151-2-4	6	-04	6.4	1/4	1/8 - 27NPTF		48	25	13	17
20151-4-4	6	-04	6.4	1/4	1/4 - 18NPTF		53	30	14	17
20151-4-5	8	-05	7.9	5/16	1/4 - 18NPTF		55	37	17	22
20151-6-5	8	-05	7.9	5/16	3/8 - 18NPTF		55	37	19	22
20151-4-6	10	-06	9.5	3/8	1/4 - 18NPTF		66	37	14	22
20151-6-6	10	-06	9.5	3/8	3/8 - 18NPTF		66	37	19	22
20151-8-6	10	-06	9.5	3/8	1/2 - 14NPTF		71	40	22	22
20151-6-8	12	-08	12.7	1/2	3/8 - 18NPTF		76	13	22	27
20151-8-8	12	-08	12.7	1/2	1/2 - 14NPTF		81	43	22	27
20151-12-12	20	-12	19.0	3/4	3/4 - 14NPTF		87	44	27	36

Material: Steel, surface protection according to DIN 50 961 Fe/Zn, special materials available upon request

20351 – JIC Male 37° Cone

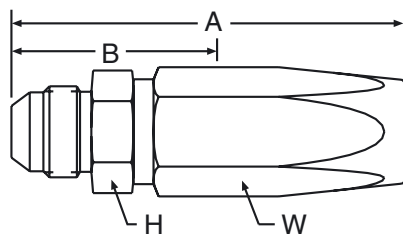

51 Series

Part No. #	DN size mm inch				Connection Type		A mm	B mm	H mm	W mm
					Thread Size	Tube OD				
20351-4-3	5	-03	4.8	3/16	7/16 - 20UNF	1/4	48	29	13	17
20351-5-4	6	-04	6.4	1/4	1/2 - 20UNF	5/16	52	29	14	17
20351-6-5	8	-05	7.9	5/16	9/16 - 18UNF	3/8	55	33	16	22
20351-6-6	10	-06	9.5	3/8	9/16 - 18UNF	3/8	66	37	19	22
20351-8-6	10	-06	9.5	3/8	3/4 - 16UNF	1/2	69	37	22	22
20351-8-8	12	-08	12.7	1/2	3/4 - 16UNF	1/2	78	41	22	27

Material: Steel, surface protection according to DIN 50 961 Fe/Zn, special materials available upon request

20651 – JIC - 37° Cone UNF Swivel Nut

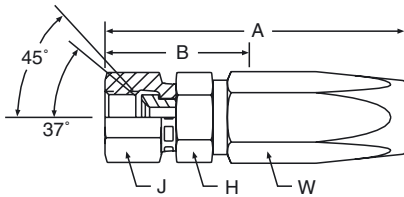

51 Series

Part No. #	DN size mm inch				Connection Type		A mm	B mm	H mm	W mm	J mm
	mm	inch	Thread Size	Tube OD							
20651-4-3	5	-03	4.8	3/16	7/16 - 20UNF	1/4	51	32	14	17	17
20651-4-4	6	-04	6.4	1/4	7/16 - 20UNF	1/4	55	32	14	17	17
20651-5-4	6	-04	6.4	1/4	1/2 - 20UNF	5/16	57	37	14	17	17
20651-6-4	6	-04	6.4	1/4	9/16 - 18UNF	3/8	59	37	14	17	19
20651-6-5	8	-05	7.9	5/16	9/16 - 18UNF	3/8	60	38	17	22	19
20651-6-6	10	-06	9.5	3/8	9/16 - 18UNF	3/8	70	37	19	22	19
20651-8-6	10	-06	9.5	3/8	3/4 - 16UNF	1/2	73	41	22	22	22
20651-8-8	12	-08	12.7	1/2	3/4 - 16UNF	1/2	83	44	22	27	22
20651-10-8	12	-08	12.7	1/2	7/8 - 14UNF	5/8	86	48	25	27	27
20651-12-12	20	-12	19.0	3/4	1 1/16 - 12UNF	3/4	95	54	27	36	32

Material: Steel, surface protection according to DIN 50 961 Fe/Zn, special materials available upon request

23951 – JIC - 37° Cone 90° Elbow UNF Swivel Nut

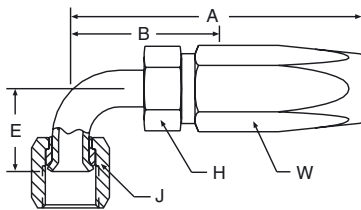

51 Series

Part No. #	DN size mm inch				Connection Type		A mm	B mm	E mm	H mm	J mm	W mm
	mm	inch	Thread Size	Tube OD								
23951-4-3	5	-03	4.8	3/16	7/16 - 20UNF	1/4	45	17	25	10	17	17
23951-6-6	10	-06	9.5	3/8	9/16 - 18UNF	3/8	69	22	37	14	19	22
23951-8-6	10	-06	9.5	3/8	3/4 - 16UNF	1/2	74	28	41	17	22	22

Material: Steel, surface protection according to DIN 50 961 Fe/Zn, special materials available upon request



20851 – SAE Male 45° Cone UNF Swivel Nut

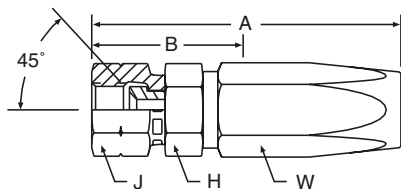

51 Series

Part No.	DN size				Connection Type		A mm	B mm	H mm	W mm	J mm
	mm	inch	Thread Size	Tube OD							
#											
20851-6-6	10	-06	9.5	3/8	5/8 - 18UNF	3/8	72	40	19	22	19

Material: Steel, surface protection according to DIN 50 961 Fe/Zn,
special materials available upon request

1C355 – Sealing Head Light Series – Metric Swivel Nut

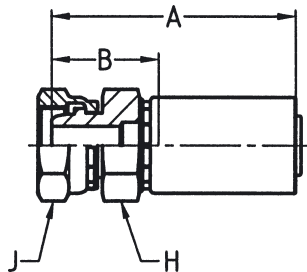

55 Series

Part No. #	DN size mm inch				Connection Type		A mm	B mm	H mm	J mm
	mm	inch	Thread Size	Tube OD						
1C355-6-3	5	-03	4.8	3/16	M12x1.5	6	52	27	14	14
1C355-8-4	6	-04	6.4	1/4	M14x1.5	8	59	27	17	19
1C355-10-4	6	-04	6.4	1/4	M16x1.5	8	59	27	19	19
1C355-10-5	8	-05	7.9	5/16	M16x1.5	10	59	27	19	19
1C355-12-5	8	-05	7.9	5/16	M18x1.5	12	61	29	19	24
1C355-10-6	10	-06	9.5	3/8	M16x1.5	10	66	29	19	22
1C355-12-6	10	-06	9.5	3/8	M18x1.5	12	66	29	19	24
1C355-15-8	12	-08	12.7	1/2	M22x1.5	15	72	31	24	27
1C355-18-12	20	-12	19.0	3/4	M26x1.5	18	80	34	32	32
1C355-22-12	20	-12	19.0	3/4	M30x2	22	84	38	32	36
1C355-28-16	25	-16	25.4	1	M36x2	28	97	37	36	46

Material: Steel, surface protection according to DIN 50 961 Fe/Zn, special materials available upon request

Note: 56 series is the recommended fitting type, as the availability of 55 series will be limited in the future.

1C455 – Sealing Head 45° Elbow Light Series – Metric Swivel Nut

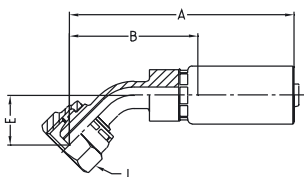

55 Series

Part No. #	DN size mm inch				Connection Type		A mm	B mm	E mm	J mm
	mm	inch	Thread Size	Tube OD						
1C455-6-3	5	-03	4.8	3/16	M12x1.5	6	67	42	16	14
1C455-8-4	6	-04	6.4	1/4	M14x1.5	8	73	42	16	19
1C455-10-5	8	-05	7.9	5/16	M16x1.5	10	74	43	17	19
1C455-10-6	10	-06	9.5	3/8	M16x1.5	10	81	45	17	19
1C455-12-6	10	-06	9.5	3/8	M18x1.5	12	82	45	18	22
1C455-15-8	12	-08	12.7	1/2	M22x1.5	15	91	50	20	27
1C455-22-12	20	-12	19.0	3/4	M30x2	22	107	61	24	36

Material: Steel, surface protection according to DIN 50 961 Fe/Zn, special materials available upon request

Note: 56 series is the recommended fitting type, as the availability of 55 series will be limited in the future.

1C555 – Sealing Head 90° Elbow Light Series – Metric Swivel Nut

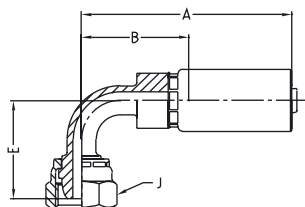

55 Series

Part No. #	DN size mm inch				Connection Type		A mm	B mm	E mm	J mm
	mm	inch	Thread Size	Tube OD						
1C555-6-3	5	-03	4.8	3/16	M12x1.5	6	57	32	29	14
1C555-8-4	6	-04	6.4	1/4	M14x1.5	8	64	32	29	19
1C555-10-4	6	-04	6.4	1/4	M16x1.5	10	64	32	29	19
1C555-10-5	8	-05	7.9	5/16	M16x1.5	10	65	33	30	19
1C555-10-6	10	-06	9.5	3/8	M16x1.5	10	73	36	33	19
1C555-12-6	10	-06	9.5	3/8	M18x1.5	12	73	36	34	22
1C555-15-6	10	-06	9.5	3/8	M22x1.5	15	73	36	36	27
1C555-15-8	12	-08	12.7	1/2	M22x1.5	15	82	41	41	27
1C555-18-12	20	-12	19.0	3/4	M26x1.5	18	100	54	52	32
1C555-22-12	20	-12	19.0	3/4	M30x2	22	100	54	52	36
1C555-28-16	25	-16	25.4	1	M36x2	28	131	71	68	46

Material: Steel, surface protection according to DIN 50 961 Fe/Zn, special materials available upon request

Note: 56 series is the recommended fitting type, as the availability of 55 series will be limited in the future.

1CA55 – 24° Sealing Cone / O-Ring Light Series – Metric Swivel Nut ISO 12151-2

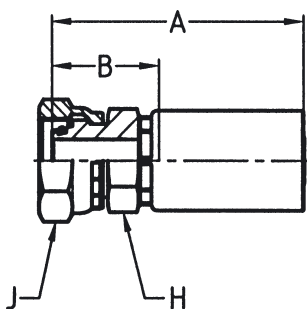

55 Series

Part No. #	DN size mm inch				Connection Type		A mm	B mm	H mm	J mm
	mm	inch	Thread Size	Tube OD						
1CA55-6-3	5	-03	4.8	3/16	M12x1.5	6	54	29	14	14
1CA55-8-4	6	-04	6.4	1/4	M14x1.5	8	60	29	17	19
1CA55-10-5	8	-05	7.9	5/16	M16x1.5	10	62	30	19	19
1CA55-12-5	8	-05	7.9	5/16	M18x1.5	12	63	31	19	22
1CA55-10-6	10	-06	9.5	3/8	M16x1.5	10	67	31	19	19
1CA55-12-6	10	-06	9.5	3/8	M18x1.5	12	68	31	19	22
1CA55-15-8	12	-08	12.7	1/2	M22x1.5	15	74	33	24	27
1CA55-18-12	20	-12	19.0	3/4	M26x1.5	18	80	34	32	32
1CA55-22-12	20	-12	19.0	3/4	M30x2	22	80	34	32	36
1CA55-28-16	25	-16	25.4	1	M36x2	28	101	41	36	46

Material: Steel, surface protection according to DIN 50 961 Fe/Zn, special materials available upon request

Note: 56 series is the recommended fitting type, as the availability of 55 series will be limited in the future.



1CE55 – 24° Sealing Cone / O-Ring 45° Elbow

Light Series – Metric Swivel Nut

ISO 12151-2

55 Series

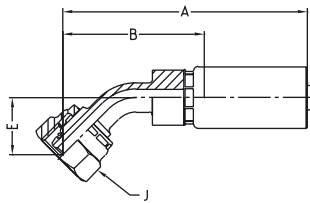

Part No. #	DN size mm inch				Connection Type		A mm	B mm	E mm	J mm
	Thread Size	Tube OD								
1CE55-6-3	5	-03	4.8	3/16	M12x1.5	6	67	42	16	14
1CE55-8-4	6	-04	6.4	1/4	M14x1.5	8	75	43	18	19
1CE55-10-4	6	-04	6.4	1/4	M16x1.5	10	75	43	17	19
1CE55-10-5	8	-05	7.9	5/16	M16x1.5	10	75	44	18	19
1CE55-10-6	10	-06	9.5	3/8	M16x1.5	10	83	46	19	19
1CE55-12-6	10	-06	9.5	3/8	M18x1.5	12	83	46	19	22
1CE55-15-8	12	-08	12.7	1/2	M22x1.5	15	92	51	21	27
1CE55-18-12	20	-12	19.0	3/4	M26x1.5	18	108	62	25	32
1CE55-22-12	20	-12	19.0	3/4	M30x2	22	108	62	26	36

Material: Steel, surface protection according to DIN 50 961 Fe/Zn, special materials available upon request

Note: 56 series is the recommended fitting type, as the availability of 55 series will be limited in the future.

1CF55 – Sealing Cone / O-Ring 90° Elbow

Light Series – Metric Swivel Nut

ISO 12151-2

55 Series

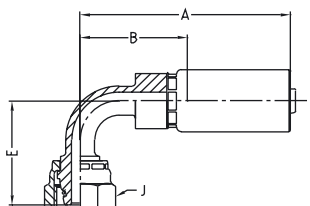

Part No. #	DN size mm inch				Connection Type		A mm	B mm	E mm	J mm
	Thread Size	Tube OD								
1CF55-6-3	5	-03	4.8	3/16	M12x1.5	6	55	30	29	14
1CF55-8-4	6	-04	6.4	1/6	M14x1.5	8	64	32	32	19
1CF55-10-4	6	-04	6.4	1/6	M16x1.5	10	64	32	31	19
1CF55-10-5	8	-05	7.9	5/16	M16x1.5	10	65	33	32	19
1CF55-12-5	8	-05	7.9	5/16	M18x1.5	12	65	33	32	22
1CF55-10-6	10	-06	9.5	3/8	M16x1.5	10	73	36	35	19
1CF55-12-6	10	-06	9.5	3/8	M18x1.5	12	73	36	35	22
1CF55-15-8	12	-08	12.7	1/2	M22x1.5	15	82	41	42	27
1CF55-18-12	20	-12	19.0	3/4	M26x1.5	18	100	54	54	32
1CF55-22-12	20	-12	19.0	3/4	M30x2	22	100	54	52	36
1CF55-28-16	25	-16	25.4	1	M36x2	28	122	62	65	46

Material: Steel, surface protection according to DIN 50 961 Fe/Zn, special materials available upon request

Note: 56 series is the recommended fitting type, as the availability of 55 series will be limited in the future.

1D055 – Metric Male 24° Cone

Light Series

ISO 12151-2

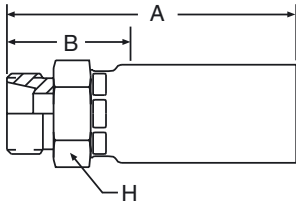

55 Series

Part No. #	DN size mm inch				Connection Type		A mm	B mm	H mm
	mm		inch		Thread Size	Tube OD			
1D055-6-3	5	-03	4.8	3/16	M12x1.5	6	49	23	17
1D055-8-4	6	-04	6.4	1/4	M14x1.5	8	55	23	19
1D055-10-5	8	-05	7.9	5/16	M16x1.5	10	58	26	19
1D055-12-5	8	-05	7.9	5/16	M18x1.5	12	59	27	19
1D055-10-6	10	-06	9.5	3/8	M16x1.5	10	63	26	22
1D055-12-6	10	-06	9.5	3/8	M18x1.5	12	64	27	22
1D055-15-6	10	-06	9.5	3/8	M22x1.5	15	67	30	27
1D055-15-8	12	-08	12.7	1/2	M22x1.5	15	71	30	27
1D055-18-12	20	-12	19.0	3/4	M26x1.5	18	76	30	32
1D055-22-12	20	-12	19.0	3/4	M30x2	22	77	31	36
1D055-28-16	25	-16	25.4	1	M36x2	28	91	31	41

Material: Steel, surface protection according to DIN 50 961 Fe/Zn, special materials available upon request

Note: 56 series is the recommended fitting type, as the availability of 55 series will be limited in the future.

11D55 – Metric Standpipe

Light Series

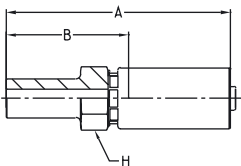

55 Series

Part No. #	DN size mm inch				Tube OD	A mm	B mm	H mm
	mm		inch					
11D55-6-2	3	-02	3.2	1/8	6	49	32	13
11D55-6-3	5	-03	4.8	3/16	6	59	33	14
11D55-6-4	6	-04	6.4	1/4	6	68	36	17
11D55-8-4	6	-04	6.4	1/4	8	68	37	17
11D55-10-5	8	-05	7.9	5/16	10	69	37	17
11D55-10-6	10	-06	9.5	3/8	10	74	37	19
11D55-12-6	10	-06	9.5	3/8	12	75	38	19
11D55-15-8	12	-08	12.7	1/2	15	82	41	22
11D55-18-8	12	-08	12.7	1/2	18	83	41	22
11D55-18-12	20	-12	19.0	3/4	18	89	43	30
11D55-22-12	20	-12	19.0	3/4	22	91	45	30
11D55-28-16	25	-16	25.4	1	28	107	47	41

Material: Steel, surface protection according to DIN 50 961 Fe/Zn, special materials available upon request

Note: 56 series is the recommended fitting type, as the availability of 55 series will be limited in the future.

Not recommended for new constructions. Please refer to end connections C3 or CA.



1C655 – Sealing Head

Heavy Series Metric Swivel Nut

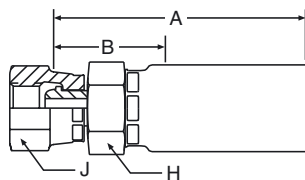

55 Series

Part No. #	DN size mm inch				Connection Type		A mm	B mm	H mm	J mm
	mm	inch	Thread Size	Tube OD						
1C655-8-3	5	-03	4.8	3/16	M16x1.5	8	53	28	17	19
1C655-10-4	6	-04	6.4	1/4	M18x1.5	10	60	28	19	22
1C655-12-5	8	-05	7.9	5/16	M20x1.5	12	64	32	22	24
1C655-14-6	10	-06	9.5	3/8	M22x1.5	14	66	30	24	27
1C655-16-8	12	-08	12.7	1/2	M24x1.5	16	72	31	27	30
1C655-20-12	20	-12	19.0	3/4	M30x2	20	84	38	32	36
1C655-25-12	20	-12	19.0	3/4	M36x2	25	82	36	36	46
1C655-30-16	25	-16	25.4	1	M42x2	30	102	42	38	50

Material: Steel, surface protection according to DIN 50 961 Fe/Zn, special materials available upon request

Note: 56 series is the recommended fitting type, as the availability of 55 series will be limited in the future.

1C955 – 24° Sealing Cone / O-Ring

Heavy Series – Metric Swivel Nut ISO 12151-2

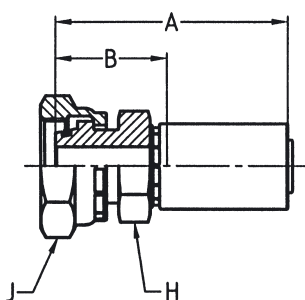

55 Series

Part No. #	DN size mm inch				Connection Type		A mm	B mm	H mm	J mm
	mm	inch	Thread Size	Tube OD						
1C955-8-3	5	-03	4.8	3/16	M16x1.5	8	54	29	17	19
1C955-8-4	6	-04	6.4	1/4	M18x1.5	8	70	38	17	19
1C955-10-4	6	-04	6.4	1/4	M18x1.5	10	67	36	19	22
1C955-12-4	6	-04	6.4	1/4	M20x1.5	12	64	32	19	24
1C955-10-5	8	-05	7.9	5/16	M18x1.5	10	63	32	19	22
1C955-12-5	8	-05	7.9	5/16	M20x1.5	12	63	32	19	24
1C955-12-6	10	-06	9.5	3/8	M20x1.5	12	68	32	19	24
1C955-14-6	10	-06	9.5	3/8	M22x1.5	14	70	33	24	27
1C955-16-8	12	-08	12.7	1/2	M24x1.5	16	77	36	24	30
1C955-20-12	20	-12	19.0	3/4	M30x2	20	84	38	30	36
1C955-25-12	20	-12	19.0	3/4	M36x2	25	88	42	36	46
1C955-30-16	25	-16	25.4	1	M42x2	30	104	44	41	50

Material: Steel, surface protection according to DIN 50 961 Fe/Zn, special materials available upon request

Note: 56 series is the recommended fitting type, as the availability of 55 series will be limited in the future.

10C55 – 24° Sealing Cone / O-Ring 45° Elbow

Heavy Series – Metric Swivel Nut

ISO 12151-2

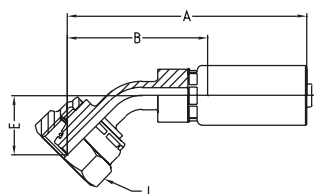

55 Series

Part No. #	DN size mm inch				Connection Type		A mm	B mm	E mm	J mm
	mm	inch	Thread Size	Tube OD						
10C55-8-3	5	-03	4.8	3/16	M16x1.5	8	68	43	18	19
10C55-16-8	12	-08	12.7	1/2	M24x1.5	16	93	52	23	30

Material: Steel, surface protection according to DIN 50 961 Fe/Zn, special materials available upon request

Note: 56 series is the recommended fitting type, as the availability of 55 series will be limited in the future.

11C55 – 24° Sealing Cone / O-Ring 90° Elbow

Heavy Series – Metric Swivel Nut

ISO 12151-2

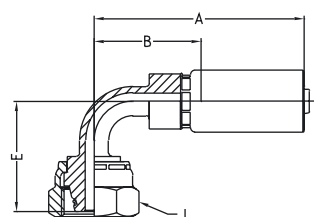

55 Series

Part No. #	DN size mm inch				Connection Type		A mm	B mm	E mm	J mm
	mm	inch	Thread Size	Tube OD						
11C55-10-4	6	-04	6.4	1/4	M18x1.5	10	64	32	31	22
11C55-12-5	8	-05	7.9	5/16	M20x1.5	12	65	33	34	24
11C55-12-6	10	-06	9.5	3/8	M20x1.5	12	73	36	37	24
11C55-16-8	12	-08	12.7	1/2	M24x1.5	16	82	41	44	30

Material: Steel, surface protection according to DIN 50 961 Fe/Zn, special materials available upon request

Note: 56 series is the recommended fitting type, as the availability of 55 series will be limited in the future.



1D255 – Metric Male 24° Cone

Heavy Series

ISO 12151-2

55 Series

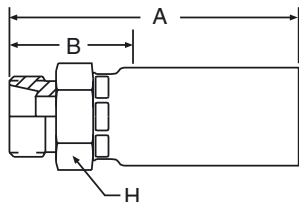

Part No. #	DN size				Connection Type		A mm	B mm	H mm
	mm	inch	mm	inch	Thread Size	Tube OD			
1D255-8-3	5	-03	4.8	3/16	M16x1.5	8	52	27	19
1D255-10-4	6	-04	6.4	1/4	M18x1.5	10	58	26	22
1D255-12-5	8	-05	7.9	5/16	M20x1.5	12	62	30	24
1D255-14-6	10	-06	9.5	3/8	M22x1.5	14	69	32	27
1D255-16-6	10	-06	9.5	3/8	M24x1.5	16	67	30	27
1D255-16-8	12	-08	12.7	1/2	M24x1.5	16	73	32	27
1D255-20-12	20	-12	19.0	3/4	M30x2	20	79	33	36
1D255-25-12	20	-12	19.0	3/4	M36x2	25	81	35	41
1D255-30-16	25	-16	25.4	1	M42x2	30	95	35	46

Material: Steel, surface protection according to DIN 50 961 Fe/Zn, special materials available upon request

Note: 56 series is the recommended fitting type, as the availability of 55 series will be limited in the future.

13D55 – Metric Standpipe

Heavy Series

55 Series

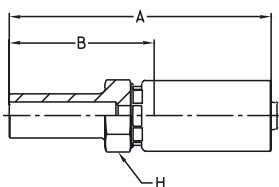

Part No. #	DN size				Tube OD	A mm	B mm	H mm
	mm	inch	mm	inch				
13D55-8-3	5	-03	4.8	3/16	8	61	35	14
13D55-8-4	6	-04	6.4	1/4	8	71	39	17
13D55-10-4	6	-04	6.4	1/4	10	70	38	17
13D55-12-5	8	-05	7.9	5/16	12	71	39	17
13D55-12-6	10	-06	9.5	3/8	12	76	39	19
13D55-14-6	10	-06	9.5	3/8	14	81	44	19
13D55-16-8	12	-08	12.7	1/2	16	87	46	22
13D55-20-12	20	-12	19.0	3/4	20	98	52	30
13D55-25-12	20	-12	19.0	3/4	25	103	57	30
13D55-30-16	25	-16	25.4	1	30	116	56	41

Material: Steel, surface protection according to DIN 50 961 Fe/Zn, special materials available upon request

Note: 56 series is the recommended fitting type, as the availability of 55 series will be limited in the future.

Not recommended for new constructions. Please refer to end connections C9.

19255 – Sealing Head (60°) BSP Swivel Nut

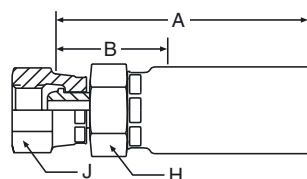

55 Series

Part No. #	DN size mm inch				Connection Type		A mm	B mm	H mm	J mm
	Thread Size	Tube OD	mm	inch	Thread Size	Tube OD				
19255-4-3	5	-03	4.8	3/16	G 1/4	1/4	53	28	17	19
19255-2-4	6	-04	6.4	1/4	G 1/8	1/8	57	25	17	14
19255-4-4	6	-04	6.4	1/4	G 1/4	1/4	58	26	17	19
19255-6-4	6	-04	6.4	1/4	G 3/8	3/8	59	27	17	22
19255-4-5	8	-05	7.9	5/16	G 1/4	1/4	59	27	19	19
19255-6-5	8	-05	7.9	5/16	G 3/8	3/8	59	27	19	22
19255-6-6	10	-06	9.5	3/8	G 3/8	3/8	64	27	19	22
19255-8-6	12	-08	12.7	1/2	G 1/2	1/2	67	30	24	27
19255-10-8	12	-08	12.7	1/2	G 5/8	5/8	75	34	27	30
19255-12-12	20	-12	19.0	3/4	G 3/4	3/4	81	35	32	32
19255-16-16	25	-16	25.4	1	G 1	1	99	39	36	41

Material: Steel, surface protection according to DIN 50 961 Fe/Zn, special materials available upon request

Note: 56 series is the recommended fitting type, as the availability of 55 series will be limited in the future.

1B155 – Sealing Head (60°) 45° Elbow BSP Swivel Nut

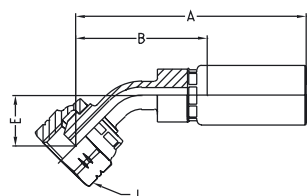

55 Series

Part No. #	DN size mm inch				Connection Type		A mm	B mm	E mm	J mm
	Thread Size	Tube OD	mm	inch	Thread Size	Tube OD				
1B155-4-4	6	-04	6.4	1/4	G 1/4	1/4	73	41	16	19
1B155-6-5	8	-05	7.9	5/16	G 3/8	3/8	74	42	16	22
1B155-6-6	10	-06	9.5	3/8	G 3/8	3/8	81	45	17	22
1B155-8-8	12	-08	12.7	1/2	G 1/2	1/2	91	49	20	27
1B155-10-8	12	-08	12.7	1/2	G 5/8	5/8	89	48	19	30
1B155-12-12	20	-12	19.0	3/4	G 3/4	3/4	107	61	25	32
1B155-16-16	25	-16	25.4	1	G 1	1	131	71	29	41

Material: Steel, surface protection according to DIN 50 961 Fe/Zn, special materials available upon request

Note: 56 series is the recommended fitting type, as the availability of 55 series will be limited in the future.



1B255 – Sealing Head (60°) 90° Elbow BSP Swivel Nut

55 Series

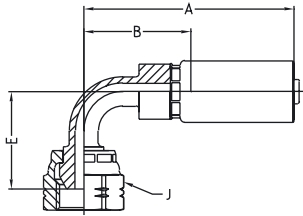

Part No. #	DN size mm inch				Connection Type		A mm	B mm	E mm	J mm
	mm	inch	mm	inch	Thread Size	Tube OD				
1B255-4-3	5	-03	4.8	3/16	G 1/4	1/4	57	32	28	19
1B255-4-4	6	-04	6.4	1/4	G 1/4	1/4	64	32	28	19
1B255-6-5	8	-05	7.9	5/16	G 3/8	3/8	65	33	30	22
1B255-6-6	10	-06	9.5	3/8	G 3/8	3/8	73	36	33	22
1B255-8-8	12	-08	12.7	1/2	G 1/2	1/2	82	41	40	27
1B255-10-8	12	-08	12.7	1/2	G 5/8	5/8	82	41	38	30
1B255-12-12	20	-12	19.0	3/4	G 3/4	3/4	100	54	53	32
1B255-16-16	25	-16	25.4	1	G 1	1	127	67	65	41

Material: Steel, surface protection according to DIN 50 961 Fe/Zn, special materials available upon request

Note: 56 series is the recommended fitting type, as the availability of 55 series will be limited in the future.

1B455 – BSP – Swivel Female 90° Compact Elbow

55 Series

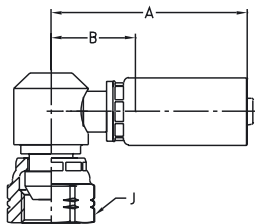

Part No. #	DN size mm inch				Connection Type		A mm	B mm	J mm
	mm	inch	mm	inch	Thread Size	Tube OD			
1B455-4-4	6	-04	6.4	1/4	G 1/4	1/4	53	21	19
1B455-6-6	10	-06	9.5	3/8	G 3/8	3/8	61	25	22
1B455-8-8	12	-08	12.7	1/2	G 1/2	1/2	68	27	27

Material: Steel, surface protection according to DIN 50 961 Fe/Zn, special materials available upon request

Note: 56 series is the recommended fitting type, as the availability of 55 series will be limited in the future.

1D955 – BSP Male DIN 3852 Shape A

55 Series

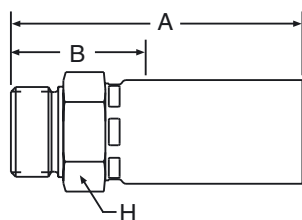

Part No. #	DN size mm inch				Connection Type		A mm	B mm	H mm
	mm	inch	mm	inch	Thread Size	Tube OD			
1D955-4-4	6	-04	6.4	1/4	G 1/4	1/4	58	26	19
1D955-6-5	8	-05	7.9	5/16	G 3/8	3/8	59	27	22
1D955-6-6	10	-06	9.5	3/8	G 3/8	3/8	64	27	22
1D955-8-8	12	-08	12.7	1/2	G 1/2	1/2	72	31	27
1D955-12-12	20	-12	19.0	3/4	G 3/4	3/4	80	34	32
1D955-16-16	25	-16	25.4	1	G 1	1	95	35	41

Material: Steel, surface protection according to DIN 50 961 Fe/Zn, special materials available upon request

Note: 56 series is the recommended fitting type, as the availability of 55 series will be limited in the future.

10155 – NPTF Male - 60° Cone

55 Series

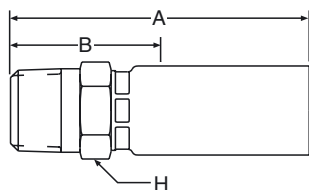

Part No. #	DN size mm inch				Connection Type		A mm	B mm	H mm
	mm	inch	mm	inch	Thread Size	Tube OD			
10155-2-3	5	-03	4.8	3/16	1/8 - 27NPTF	1/8	51	26	14
10155-4-3	5	-03	4.8	3/16	1/4 - 18NPTF	1/4	55	30	17
10155-6-3	5	-03	4.8	3/16	3/8 - 18NPTF	3/8	54	29	19
10155-2-4	6	-04	6.4	1/4	1/8 - 27NPTF	1/8	54	22	17
10155-4-4	6	-04	6.4	1/4	1/4 - 18NPTF	1/4	62	30	17
10155-6-4	6	-04	6.4	1/4	3/8 - 18NPTF	3/8	61	29	19
10155-4-5	8	-05	7.9	5/16	1/4 - 18NPTF	1/4	59	27	17
10155-6-5	8	-05	7.9	5/16	3/8 - 18NPTF	3/8	61	29	19
10155-4-6	10	-06	9.5	3/8	1/4 - 18NPTF	1/4	66	30	19
10155-6-6	10	-06	9.5	3/8	3/8 - 18NPTF	3/8	70	33	19
10155-8-6	10	-06	9.5	3/8	1/2 - 14NPTF	1/2	77	40	27
10155-6-8	12	-08	12.7	1/2	3/8 - 18NPTF	3/8	71	30	22
10155-8-8	12	-08	12.7	1/2	1/2 - 14NPTF	1/2	77	36	27
10155-12-12	20	-12	19.0	3/4	3/4 - 14NPTF	3/4	82	36	30
10155-16-16	25	-06	25.4	1	1 - 11 1/2NPTF	1	104	44	41

Material: Steel, surface protection according to DIN 50 961 Fe/Zn, special materials available upon request

Note: 56 series is the recommended fitting type, as the availability of 55 series will be limited in the future.

10355 – JIC Male 37° Cone

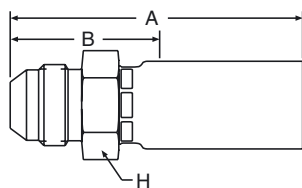

55 Series

Part No. #	DN size mm inch				Connection Type		A mm	B mm	H mm
					Thread Size 	Tube OD 			
10355-4-3	5	-03	4.8	3/16	7/16 - 20UNF	1/4	52	27	14
10355-4-4	6	-04	6.4	1/4	7/16 - 20UNF	1/4	58	27	17
10355-5-4	6	-04	6.4	1/4	1/2 - 20UNF	5/16	58	27	17
10355-6-4	6	-04	6.4	1/4	1/2 - 20UNF	5/16	59	27	17
10355-5-5	8	-05	7.9	5/16	9/16 - 18UNF	3/8	62	30	17
10355-6-5	8	-05	7.9	5/16	9/16 - 18UNF	3/8	62	30	17
10355-6-6	10	-06	9.5	3/8	9/16 - 18UNF	3/8	70	33	19
10355-8-6	10	-06	9.5	3/8	3/4 - 16UNF	1/2	68	32	22
10355-8-8	12	-08	12.7	1/2	3/4 - 16UNF	1/2	73	32	22
10355-10-8	12	-08	12.7	1/2	7/8 - 14UNF	5/8	81	40	27
10355-12-12	20	-12	19.0	3/4	1 1/16 - 12UNF	3/4	84	38	30
10355-16-16	25	-06	25.4	1	1 5/16 - 12UNF	1	104	44	36

Material: Steel, surface protection according to DIN 50 961 Fe/Zn, special materials available upon request

Note: 56 series is the recommended fitting type, as the availability of 55 series will be limited in the future.

10555 – UNF Male / O-Ring

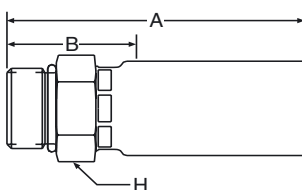

55 Series

Part No. #	DN size mm inch				Connection Type		A mm	B mm	H mm
					Thread Size 	Tube OD 			
10555-4-3	5	-03	4.8	3/16	7/16 - 20UNF	1/4	47	22	14
10555-4-4	6	-04	6.4	1/4	7/16 - 20UNF	1/4	57	25	17
10555-5-4	6	-04	6.4	1/4	1/2 - 20UNF	5/16	54	22	17
10555-6-4	6	-04	6.4	1/4	9/16 - 18UNF	3/8	58	26	19
10555-4-5	8	-05	7.9	5/16	7/16 - 20UNF	1/4	53	22	17
10555-5-5	8	-05	7.9	5/16	1/2 - 20UNF	5/16	53	22	17
10555-6-6	10	-06	9.5	3/8	9/16 - 18UNF	3/8	61	25	19
10555-8-6	10	-06	9.5	3/8	3/4 - 16UNF	1/2	63	26	22
10555-8-8	12	-08	12.7	1/2	3/4 - 16UNF	1/2	67	26	22
10555-10-8	12	-08	12.7	1/2	7/8 - 14UNF	5/8	70	29	24

Material: Steel, surface protection according to DIN 50 961 Fe/Zn, special materials available upon request

Note: 56 series is the recommended fitting type, as the availability of 55 series will be limited in the future.

10655 – JIC - 37° Cone

UNF Swivel Nut

Material: Steel

55 Series

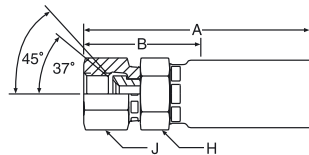

Part No. #	DN size mm inch				Connection Type		A mm	B mm	H mm	J mm
	Thread Size	Tube OD								
10655-4-2	3	-02	3.2	1/8	7/16 - 20UNF	1/4	44	27	13	16
10655-4-3	5	-03	4.8	3/16	7/16 - 20UNF	1/4	55	30	16	17
10655-5-3	5	-03	4.8	3/16	1/2 - 20UNF	5/16	57	32	16	17
10655-4-4	6	-04	6.4	1/4	7/16 - 20UNF	1/4	65	33	17	17
10655-5-4	6	-04	6.4	1/4	1/2 - 20UNF	5/16	65	33	16	17
10655-6-4	6	-04	6.4	1/4	9/16 - 18UNF	3/8	67	35	17	19
10655-5-5	8	-05	7.9	5/16	1/2 - 20UNF	5/16	65	33	16	17
10655-6-5	8	-05	7.9	5/16	9/16 - 18UNF	3/8	65	33	16	19
10655-8-5	8	-05	7.9	5/16	3/4 - 16UNF	1/2	68	37	19	22
10655-6-6	10	-06	9.5	3/8	9/16 - 18UNF	3/8	69	33	19	19
10655-8-6	10	-06	9.5	3/8	3/4 - 16UNF	1/2	72	35	19	24
10655-6-8	12	-08	12.7	1/2	9/16 - 18UNF	3/8	76	35	22	19
10655-8-8	12	-08	12.7	1/2	3/4 - 16UNF	1/2	79	38	22	22
10655-10-8	12	-08	12.7	1/2	7/8 - 14UNF	5/8	82	41	22	27
10655-12-8	12	-08	12.7	1/2	1 1/16 - 12UNF	3/4	83	42	27	32
10655-12-12	20	-12	19.0	3/4	1 1/16 - 12UNF	3/4	88	42	30	32
10655-16-16	25	-16	25.4	1	1 5/16 - 12UNF	1	104	44	36	38

Material: Steel, surface protection according to DIN 50 961 Fe/Zn, special materials available upon request

Note: 56 series is the recommended fitting type, as the availability of 55 series will be limited in the future.

Material: Stainless Steel (AISI 316)



Part No. #	DN size mm inch				Connection Type		A mm	B mm	H mm	J mm
	Thread Size	Tube OD								
10655-4-3C	5	-03	4.8	3/16	7/16 - 20UNF	1/4	55	30	16	17
10655-4-4C	6	-04	6.4	1/4	7/16 - 20UNF	1/4	65	33	17	17
10655-5-4C	6	-04	6.4	1/4	1/2 - 20UNF	5/16	65	33	16	17
10655-6-4C	6	-04	6.4	1/4	9/16 - 18UNF	3/8	67	35	17	19
10655-6-5C	8	-05	7.9	5/16	9/16 - 18UNF	3/8	65	33	16	19
10655-6-6C	10	-06	9.5	3/8	9/16 - 18UNF	3/8	69	33	19	19
10655-8-6C	10	-06	9.5	3/8	3/4 - 16UNF	1/2	72	35	19	24
10655-8-8C	12	-08	12.7	1/2	3/4 - 16UNF	1/2	79	38	22	22
10655-10-8C	12	-08	12.7	1/2	7/8 - 14UNF	5/8	82	41	22	27
10655-12-12C	20	-12	19.0	3/4	1 1/16 - 12UNF	3/4	88	42	30	32
10655-16-16C	25	-16	25.4	1	1 5/16 - 12UNF	1	104	44	36	38

Material: Stainless steel (AISI 316)

Note: 56 series is the recommended fitting type, as the availability of 55 series will be limited in the future.

13755 – JIC - 37° Cone 45° Elbow UNF Swivel Nut

55 Series

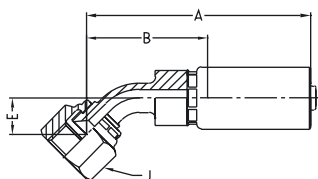

Part No. #	DN size mm inch				Connection Type		A mm	B mm	E mm	J mm
	mm	inch	Thread Size	Tube OD						
13755-4-3-SM	5	-03	4.8	3/16	7/16 - 20UNF	1/4	61	30	11	17
13755-4-4-SM	6	-04	6.4	1/4	7/16 - 20UNF	1/4	68	36	10	17
13755-5-4-SM	6	-04	6.4	1/4	1/2 - 20UNF	5/16	70	38	13	17
13755-6-5-SM	8	-05	7.9	5/16	9/16 - 18UNF	3/8	69	37	11	19
13755-6-6-SM	10	-06	9.5	3/8	9/16 - 18UNF	3/8	77	40	14	19
13755-8-6-SM	10	-06	9.5	3/8	3/4 - 16UNF	1/2	78	42	15	22
13755-8-8-SM	12	-08	12.7	1/2	3/4 - 16UNF	1/2	83	42	14	22
13755-10-8-SM	12	-08	12.7	1/2	7/8 - 14UNF	5/8	85	44	16	27
13755-12-12-SM	20	-12	19.0	3/4	1 1/16 - 12UNF	3/4	100	54	20	32
13755-16-16-SM	25	-16	25.4	1	1 5/16 - 12UNF	1	124	64	24	41

Material: Steel, surface protection according to DIN 50 961 Fe/Zn, special materials available upon request

Note: 56 series is the recommended fitting type, as the availability of 55 series will be limited in the future.

13955 – JIC - 37° Cone 90° Elbow UNF Swivel Nut

55 Series

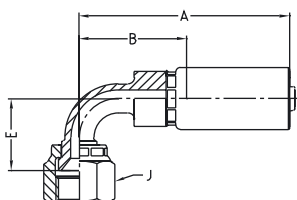

Part No. #	DN size mm inch				Connection Type		A mm	B mm	E mm	J mm
	mm	inch	Thread Size	Tube OD						
13955-4-3-SM	5	-03	4.8	3/16	7/16 - 20UNF	1/4	55	30	21	17
13955-4-4-SM	6	-04	6.4	1/4	7/16 - 20UNF	1/4	64	32	21	17
13955-5-4-SM	6	-04	6.4	1/4	1/2 - 20UNF	5/16	64	32	25	17
13955-6-4-SM	6	-04	6.4	1/4	9/16 - 18UNF	3/8	64	32	22	19
13955-6-5-SM	8	-05	7.9	5/16	9/16 - 18UNF	3/8	65	33	22	19
13955-6-6-SM	10	-06	9.5	3/8	9/16 - 18UNF	3/8	73	36	28	19
13955-8-6-SM	10	-06	9.5	3/8	3/4 - 16UNF	1/2	71	34	29	22
13955-8-8-SM	12	-08	12.7	1/2	3/4 - 16UNF	1/2	77	36	29	22
13955-10-8-SM	12	-08	12.7	1/2	7/8 - 14UNF	5/8	77	36	32	27
13955-12-12-SM	20	-12	19.0	3/4	1 1/16 - 12UNF	3/4	97	51	46	32
13955-16-16-SM	25	-16	25.4	1	1 5/16 - 12UNF	1	121	61	55	41

Material: Steel, surface protection according to DIN 50 961 Fe/Zn, special materials available upon request



Note: 56 series is the recommended fitting type, as the availability of 55 series will be limited in the future.

1JC55 – O-Lok® ORFS

(Short Version)
UNF Swivel Nut
ISO 12151-1

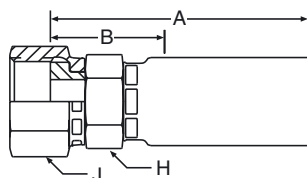
55 Series



Part No. #	DN size mm inch				Connection Type		A mm	B mm	H mm	J mm
										
1JC55-4-3-SM	5	-03	4.8	3/16	9/16 - 18UNF	1/4	47	22	17	17
1JC55-4-4-SM	6	-04	6.4	1/4	9/16 - 18UNF	1/4	53	22	17	17
1JC55-6-4-SM	6	-04	6.4	1/4	11/16 - 16UNF	3/8	59	27	19	22
1JC55-4-5-SM	8	-05	7.9	5/16	9/16 - 16UNF	1/4	53	22	17	17
1JC55-6-5-SM	8	-05	7.9	5/16	11/16 - 16UNF	3/8	56	25	19	22
1JC55-6-6-SM	10	-06	9.5	3/8	11/16 - 16UNF	3/8	61	25	19	22
1JC55-8-6-SM	10	-06	9.5	3/8	13/16 - 16UNF	1/2	63	27	22	24
1JC55-8-8-SM	12	-08	12.7	1/2	13/16 - 16UNF	1/2	69	27	24	24
1JC55-10-8-SM	12	-08	12.7	1/2	1 - 14UNF	5/8	73	32	30	30
1JC55-12-12-SM	20	-12	19.0	3/4	1 3/16 - 12UNF	3/4	79	33	32	36
1JC55-16-16-SM	25	-16	25.4	1	1 7/16 - 12UNF	1	96	36	36	41

Material: Steel, surface protection according to DIN 50 961 Fe/Zn, special materials available upon request



Note: 56 series is the recommended fitting type, as the availability of 55 series will be limited in the future.

1JS55 – O-Lok® ORFS

UNF Swivel Nut
ISO 12151-1

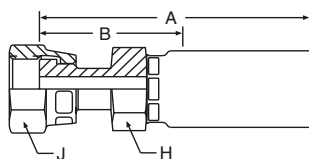
55 Series



Part No. #	DN size mm inch				Connection Type		A mm	B mm	H mm	J mm
										
1JS55-4-3-SM	5	-03	4.8	3/16	9/16 - 18UNF	1/4	60	35	17	17
1JS55-4-4-SM	6	-04	6.4	1/4	9/16 - 18UNF	1/4	67	35	17	17
1JS55-6-4-SM	6	-04	6.4	1/4	11/16 - 16UNF	3/8	66	35	19	22
1JS55-4-5-SM	8	-05	7.9	5/16	9/16 - 16UNF	1/4	67	35	17	17
1JS55-6-5-SM	8	-05	7.9	5/16	11/16 - 16UNF	3/8	66	35	19	22
1JS55-6-6-SM	10	-06	9.5	3/8	11/16 - 16UNF	3/8	71	35	19	22
1JS55-8-6-SM	10	-06	9.5	3/8	13/16 - 16UNF	1/2	75	38	22	24
1JS55-8-8-SM	12	-08	12.7	1/2	13/16 - 16UNF	1/2	80	38	22	24
1JS55-10-10-SM	16	-10	15.9	5/8	1 - 14UNF	5/8	90	44	30	30
1JS55-12-12-SM	20	-12	19.0	3/4	1 3/16 - 12UNF	3/4	94	48	32	36
1JS55-16-16-SM	25	-16	25.4	1	1 7/16 - 12UNF	1	112	52	36	41

Material: Steel, surface protection according to DIN 50 961 Fe/Zn, special materials available upon request

Note: 56 series is the recommended fitting type, as the availability of 55 series will be limited in the future.



1JM55 – O-Lok® ORFS Male ISO 12151-1

55 Series

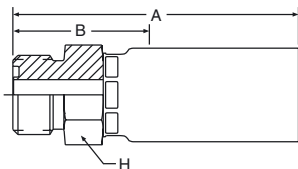

Part No. #	DN size mm inch				Connection Type		A mm	B mm	H mm
	mm	inch	Thread Size	Tube OD					
1JM55-4-4-SM	6	-04	6.4	1/4	9/16 - 18UNF	1/4	56	24	19
1JM55-6-6-SM	10	-06	9.5	3/8	11/16 - 16UNF	3/8	63	26	19
1JM55-8-6-SM	10	-06	9.5	3/8	13/16 - 16UNF	1/2	65	28	22

Material: Steel, surface protection according to DIN 50 961 Fe/Zn, special materials available upon request

Note: 56 series is the recommended fitting type, as the availability of 55 series will be limited in the future.

1J755 – O-Lok® ORFS 45° Elbow UNF Swivel Nut ISO 12151-1

55 Series

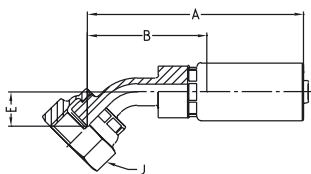

Part No. #	DN size mm inch				Connection Type		A mm	B mm	E mm	H mm
	mm	inch	Thread Size	Tube OD						
1J755-4-4	6	-04	6.4	1/4	9/16 - 18UNF	5/16	71	39	10	17
1J755-6-4	6	-04	6.4	1/4	11/16 - 16UNF	3/8	73	41	12	22
1J755-6-6	10	-06	9.5	3/8	11/16 - 16UNF	3/8	78	41	14	22
1J755-8-6	10	-06	9.5	3/8	13/16 - 16UNF	1/2	78	42	14	24
1J755-8-8	12	-08	12.7	1/2	13/16 - 16UNF	1/2	83	42	12	24
1J755-12-12	20	-12	19.0	3/4	1 3/16 - 12UNF	3/4	103	57	21	36
1J755-16-16	25	-16	25.4	1	1 7/16 - 12UNF	1	130	70	26	41

Material: Steel, surface protection according to DIN 50 961 Fe/Zn, special materials available upon request

Note: 56 series is the recommended fitting type, as the availability of 55 series will be limited in the future.

1J955 – O-Lok® ORFS 90° Elbow UNF Swivel Nut ISO 12151-1

55 Series

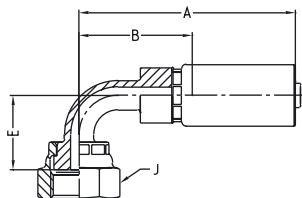

Part No. #	DN size mm inch				Connection Type		A mm	B mm	E mm	J mm
	Thread Size	Tube OD								
1J955-4-4	6	-04	6.4	1/4	9/16 - 18UNF	5/16	67	35	21	17
1J955-6-4	6	-04	6.4	1/4	11/16 - 16UNF	3/8	68	36	23	22
1J955-6-5	8	-05	7.9	5/16	11/16 - 16UNF	3/8	67	35	23	22
1J955-6-6	10	-06	9.5	3/8	11/16 - 16UNF	3/8	72	36	29	22
1J955-8-8	12	-08	12.7	1/2	13/16 - 16UNF	1/2	82	41	29	24
1J955-12-12	20	-12	19.0	3/4	1 3/16 - 12UNF	3/4	100	54	47	36
1J955-16-16	25	-16	25.4	1	1 7/16 - 12UNF	1	128	68	64	41

Material: Steel, surface protection according to DIN 50 961 Fe/Zn, special materials available upon request

Note: 56 series is the recommended fitting type, as the availability of 55 series will be limited in the future.

1J155 – O-Lok® ORFS 90° Elbow (Long Drop Length) UNF Swivel Nut ISO 12151-1

55 Series

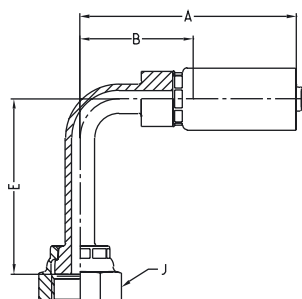

Part No. #	DN size mm inch				Connection Type		A mm	B mm	E mm	J mm
	Thread Size	Tube OD								
1J155-4-4	6	-04	6.4	1/4	9/16 - 18UNF	5/16	67	35	46	17
1J155-6-6	10	-06	9.5	3/8	11/16 - 16UNF	3/8	72	36	54	22
1J155-8-6	10	-06	9.5	3/8	13/16 - 16UNF	1/2	72	36	64	24
1J155-8-8	12	-08	12.7	1/2	13/16 - 16UNF	1/2	82	41	64	24
1J155-12-12	20	-12	19.0	3/4	1 3/16 - 12UNF	3/4	100	54	96	36
1J155-16-16	25	-16	25.4	1	1 7/16 - 12UNF	1	128	68	114	41

Material: Steel, surface protection according to DIN 50 961 Fe/Zn, special materials available upon request





Note: 56 series is the recommended fitting type, as the availability of 55 series will be limited in the future.

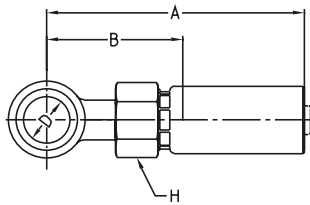

14955 – Banjo Union DIN 7642



55 Series

Part No. #	DN size mm inch				Tube OD	A mm	B mm	H mm
								
14955-10-4	6	-04	6.4	1/4	10	65	34	17
14955-12-4	6	-04	6.4	1/4	12	67	36	–
14955-14-4	6	-04	6.4	1/4	14	72	40	17
14955-12-5	8	-05	7.9	5/16	12	61	30	–
14955-14-5	8	-05	7.9	5/16	14	72	40	17
14955-12-6	10	-06	9.5	3/8	12	66	29	–

Material: Steel, surface protection according to DIN 50 961 Fe/Zn, special materials available upon request

Note: 56 series is the recommended fitting type, as the availability of 55 series will be limited in the future.

1C356 – Sealing Head

Light Series – Metric Swivel Nut

56 Series

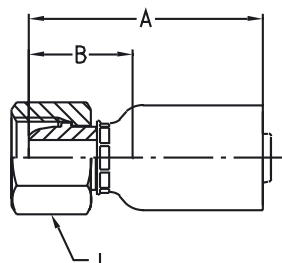

Part No. #	DN size mm inch				Connection Type		A mm	B mm	H mm
	mm	inch	Thread Size	Tube OD					
1C356-6-3	5	-03	4.8	3/16	M12x1.5	6	37	20	14
1C356-8-4	6	-04	6.4	1/4	M14x1.5	8	44	20	17
1C356-10-4	6	-04	6.4	1/4	M16x1.5	10	45	21	19
1C356-10-5	8	-05	7.9	5/16	M16x1.5	10	46	20	19
1C356-12-5	8	-05	7.9	5/16	M18x1.5	12	47	21	22
1C356-10-6	10	-06	9.5	3/8	M16x1.5	10	46	20	19
1C356-12-6	10	-06	9.5	3/8	M18x1.5	12	47	22	22
1C356-15-8	12	-08	12.7	1/2	M22x1.5	15	50	23	27
1C356-18-12	20	-12	19.0	3/4	M26x1.5	18	58	24	32
1C356-22-12	20	-12	19.0	3/4	M30x2	22	57	24	36
1C356-28-16	25	-16	25.4	1	M36x2	28	76	28	41

Material: Steel, surface protection according to DIN 50 961 Fe/Zn, special materials available upon request

1C456 – Sealing Head 45° Elbow

Light Series – Metric Swivel Nut



56 Series

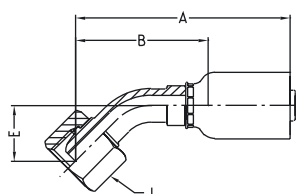

Part No. #	DN size mm inch				Connection Type		A mm	B mm	E mm	J mm
	mm	inch	Thread Size	Tube OD						
1C456-6-3	5	-03	4.8	3/16	M12x1.5	6	57	39	16	14
1C456-8-4	6	-04	6.4	1/4	M14x1.5	8	62	38	16	17
1C456-10-5	8	-05	7.9	5/16	M16x1.5	10	67	41	17	19
1C456-10-6	10	-06	9.5	3/8	M16x1.5	10	67	41	17	19
1C456-12-6	10	-06	9.5	3/8	M18x1.5	12	68	43	18	22
1C456-15-8	12	-08	12.7	1/2	M22x1.5	15	76	47	19	27

Material: Steel, surface protection according to DIN 50 961 Fe/Zn, special materials available upon request

1C556 – Sealing Head 90° Elbow Light Series – Metric Swivel Nut

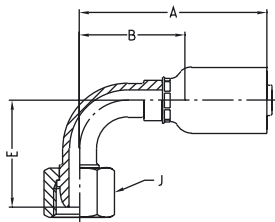

56 Series

Part No. #	DN size mm inch				Connection Type		A mm	B mm	E mm	J mm
	mm	inch	Thread Size	Tube OD						
1C556-6-3	5	-03	4.8	3/16	M12x1.5	6	46	28	28	14
1C556-8-4	6	-04	6.4	1/4	M14x1.5	8	53	29	28	17
1C556-10-4	6	-04	6.4	1/4	M16x1.5	10	53	29	29	19
1C556-10-5	8	-05	7.9	5/16	M16x1.5	10	58	33	33	19
1C556-10-6	10	-06	9.5	3/8	M16x1.5	10	58	33	33	19
1C556-12-6	10	-06	9.5	3/8	M18x1.5	12	58	33	34	22
1C556-15-6	10	-06	9.5	3/8	M22x1.5	15	58	33	34	27
1C556-15-8	12	-08	12.7	1/2	M22x1.5	15	68	40	39	27
1C556-18-12	20	-12	19.0	3/4	M26x1.5	18	87	53	52	32

Material: Steel, surface protection according to DIN 50 961 Fe/Zn, special materials available upon request

1CA56 – 24° Sealing Cone / O-Ring Light Series – Metric Swivel Nut ISO 12151-2

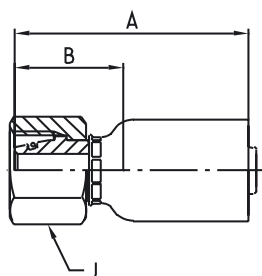

56 Series

Part No. #	DN size mm inch				Connection Type		A mm	B mm	J mm
	mm	inch	Thread Size	Tube OD					
1CA56-6-3	5	-03	4.8	3/16	M12x1.5	6	39	22	14
1CA56-8-4	6	-04	6.4	1/4	M14x1.5	8	47	23	17
1CA56-10-5	8	-05	7.9	5/16	M16x1.5	10	48	22	19
1CA56-12-5	8	-05	7.9	5/16	M18x1.5	12	48	23	22
1CA56-10-6	10	-06	9.5	3/8	M16x1.5	10	48	23	19
1CA56-12-6	10	-06	9.5	3/8	M18x1.5	12	48	23	22
1CA56-15-8	12	-08	12.7	1/2	M22x1.5	15	52	24	27
1CA56-18-12	20	-12	19.0	3/4	M26x1.5	18	60	26	32
1CA56-22-12	20	-12	19.0	3/4	M30x2	22	62	28	36
1CA56-28-16	25	-16	25.4	1	M36x2	28	78	30	46

Material: Steel, surface protection according to DIN 50 961 Fe/Zn, special materials available upon request

1CE56 – 24° Sealing Cone / O-Ring 45° Elbow

Light Series – Metric Swivel Nut

ISO 12151-2

56 Series

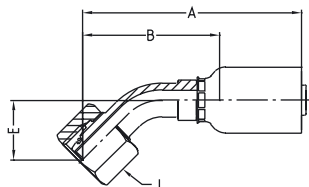

Part No. #	DN size mm inch				Connection Type		A mm	B mm	E mm	J mm
	mm	inch	Thread Size	Tube OD						
1CE56-6-3	5	-03	4.8	3/16	M12x1.5	6	58	40	17	14
1CE56-8-4	6	-04	6.4	1/4	M14x1.5	8	65	40	18	17
1CE56-10-4	6	-04	6.4	1/4	M16x1.5	10	64	40	17	19
1CE56-10-5	8	-05	7.9	5/16	M16x1.5	10	66	40	18	19
1CE56-10-6	10	-06	9.5	3/8	M16x1.5	10	68	43	19	19
1CE56-12-6	10	-06	9.5	3/8	M18x1.5	12	69	44	19	22
1CE56-15-8	12	-08	12.7	1/2	M22x1.5	15	77	49	21	27
1CE56-18-12	20	-12	19.0	3/4	M26x1.5	18	95	61	25	32
1CE56-22-12	20	-12	19.0	3/4	M30x2	22	96	62	26	36

Material: Steel, surface protection according to DIN 50 961 Fe/Zn, special materials available upon request

1CF56 – Sealing Cone / O-Ring 90° Elbow

Light Series – Metric Swivel Nut

ISO 12151-2

56 Series

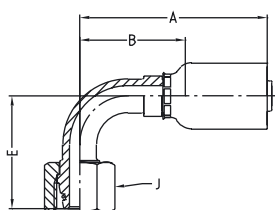

Part No. #	DN size mm inch				Connection Type		A mm	B mm	E mm	J mm
	mm	inch	Thread Size	Tube OD						
1CF56-6-3	5	-03	4.8	3/16	M12x1.5	6	46	28	30	14
1CF56-8-4	6	-04	6.4	1/6	M14x1.5	8	53	29	32	17
1CF56-10-4	6	-04	6.4	1/6	M16x1.5	10	53	29	31	19
1CF56-10-5	8	-05	7.9	5/16	M16x1.5	10	55	30	32	19
1CF56-12-5	8	-05	7.9	5/16	M18x1.5	12	56	30	33	22
1CF56-10-6	10	-06	9.5	3/8	M16x1.5	10	58	33	35	19
1CF56-12-6	10	-06	9.5	3/8	M18x1.5	12	58	36	33	22
1CF56-15-8	12	-08	12.7	1/2	M22x1.5	15	68	40	41	27
1CF56-18-12	20	-12	19.0	3/4	M26x1.5	18	87	54	53	32
1CF56-22-12	20	-12	19.0	3/4	M30x2	22	87	54	65	36
1CF56-28-16	25	-16	25.4	1	M36x2	28	115	67	69	41

Material: Steel, surface protection according to DIN 50 961 Fe/Zn, special materials available upon request



1D056 – Metric Male 24° Cone

Light Series ISO 12151-2

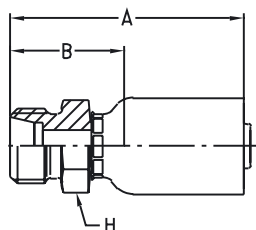

56 Series

Part No. #	DN size mm inch				Connection Type		A mm	B mm	H mm
					Thread Size 	Tube OD 			
1D056-6-3	5	-03	4.8	3/16	M12x1.5	6	41	23	12
1D056-8-4	6	-04	6.4	1/4	M14x1.5	8	48	23	14
1D056-10-5	8	-05	7.9	5/16	M16x1.5	10	50	24	17
1D056-12-5	8	-05	7.9	5/16	M18x1.5	12	52	26	19
1D056-10-6	10	-06	9.5	3/8	M16x1.5	10	50	25	17
1D056-12-6	10	-06	9.5	3/8	M18x1.5	12	52	26	19
1D056-15-6	10	-06	9.5	3/8	M22x1.5	15	53	27	22
1D056-15-8	12	-08	12.7	1/2	M22x1.5	15	56	28	24
1D056-18-12	20	-12	19.0	3/4	M26x1.5	18	66	33	27
1D056-22-12	20	-12	19.0	3/4	M30x2	22	67	33	32
1D056-28-16	25	-16	25.4	1	M36x2	28	84	36	36

Material: Steel, surface protection according to DIN 50 961 Fe/Zn, special materials available upon request

11D56 – Metric Standpipe

Light Series

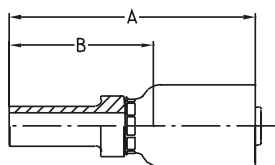

56 Series

Part No. #	DN size mm inch				Tube OD	A mm	B mm
11D56-6-3	5	-03	4.8	3/16	6	50	32
11D56-6-4	6	-04	6.4	1/4	6	57	32
11D56-8-4	6	-04	6.4	1/4	8	57	32
11D56-10-5	8	-05	7.9	5/16	10	60	34
11D56-10-6	10	-06	9.5	3/8	10	60	34
11D56-12-6	10	-06	9.5	3/8	12	61	35
11D56-15-8	12	-08	12.7	1/2	15	66	39
11D56-18-8	12	-08	12.7	1/2	18	68	41
11D56-18-12	20	-12	19.0	3/4	18	74	40
11D56-22-12	20	-12	19.0	3/4	22	76	42
11D56-28-16	25	-16	25.4	1	28	94	46

Material: Steel, surface protection according to DIN 50 961 Fe/Zn, special materials available upon request

Not recommended for new constructions. Please refer to end connections C3 or CA.

1C656 – Sealing Head

Heavy Series Metric Swivel Nut

56 Series

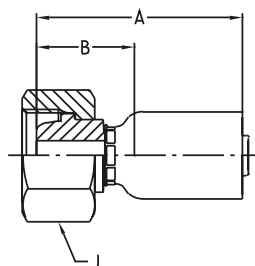

Part No. #	DN size mm inch				Connection Type		A mm	B mm	J mm
	mm		inch		Thread Size	Tube OD			
1C656-8-3	5	-03	4.8	3/16	M16x1.5	8	37	20	19
1C656-10-4	6	-04	6.4	1/4	M18x1.5	10	46	22	22
1C656-12-5	8	-05	7.9	5/16	M20x1.5	12	50	24	24
1C656-14-6	10	-06	9.5	3/8	M22x1.5	14	49	24	27
1C656-16-8	12	-08	12.7	1/2	M24x1.5	16	53	27	30
1C656-20-12	20	-12	19.0	3/4	M30x2	20	61	27	36

Material: Steel, surface protection according to DIN 50 961 Fe/Zn, special materials available upon request

1C956 – 24° Sealing Cone / O-Ring

Heavy Series – Metric Swivel Nut ISO 12151-2

56 Series

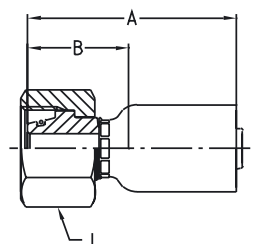

Part No. #	DN size mm inch				Connection Type		A mm	B mm	J mm
	mm		inch		Thread Size	Tube OD			
1C956-8-3	5	-03	4.8	3/16	M16x1.5	8	41	23	19
1C956-8-4	6	-04	6.4	1/4	M16x1.5	8	48	23	19
1C956-10-4	6	-04	6.4	1/4	M18x1.5	10	48	23	22
1C956-12-4	6	-04	6.4	1/4	M20x1.5	12	49	24	24
1C956-10-5	8	-05	7.9	5/16	M18x1.5	10	49	23	22
1C956-12-5	8	-05	7.9	5/16	M20x1.5	12	50	24	24
1C956-12-6	10	-06	9.5	3/8	M20x1.5	12	49	24	24
1C956-14-6	10	-06	9.5	3/8	M22x1.5	14	49	24	27
1C956-16-8	12	-08	12.7	1/2	M24x1.5	16	55	27	30
1C956-20-12	20	-12	19.0	3/4	M30x2	20	65	31	36
1C956-25-12	20	-12	19.0	3/4	M36x2	25	66	33	46

Material: Steel, surface protection according to DIN 50 961 Fe/Zn, special materials available upon request



10C56 – 24° Sealing Cone / O-Ring 45° Elbow

Heavy Series – Metric Swivel Nut

ISO 12151-2

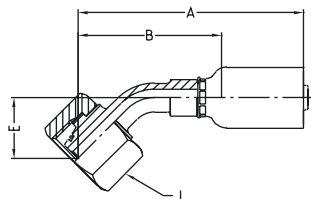

56 Series

Part No. #	DN size mm inch				Connection Type		A mm	B mm	E mm	J mm
	Thread Size	Tube OD								
10C56-10-4	6	-04	6.4	1/4	M18x1.5	10	65	40	18	22
10C56-12-5	8	-05	7.9	5/16	M20x1.5	12	70	45	19	24
10C56-12-6	10	-06	9.5	3/8	M20x1.5	12	70	45	20	24
10C56-16-8	12	-08	12.7	1/2	M24x1.5	16	80	51	23	30

Material: Steel, surface protection according to DIN 50 961 Fe/Zn, special materials available upon request

11C56 – 24° Sealing Cone / O-Ring 90° Elbow

Heavy Series – Metric Swivel Nut

ISO 12151-2

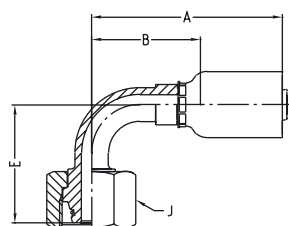

56 Series

Part No. #	DN size mm inch				Connection Type		A mm	B mm	E mm	J mm
	Thread Size	Tube OD								
11C56-10-4	6	-04	6.4	1/4	M18x1.5	10	53	29	32	22
11C56-12-5	8	-05	7.9	5/16	M20x1.5	12	58	33	34	24
11C56-12-6	10	-06	9.5	3/8	M20x1.5	12	59	34	37	24
11C56-16-8	12	-08	12.7	1/2	M24x1.5	16	68	40	45	30

Material: Steel, surface protection according to DIN 50 961 Fe/Zn, special materials available upon request

1D256 – Metric Male 24° Cone

Heavy Series ISO 12151-2

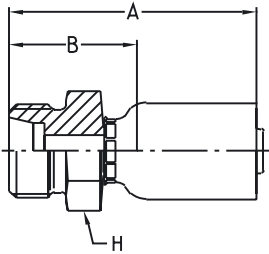

56 Series

Part No. #	DN size mm inch				Connection Type		A mm	B mm	H mm
					Thread Size 	Tube OD 			
1D256-8-3	5	-03	4.8	3/16	M16x1.5	8	43	25	17
1D256-10-4	6	-04	6.4	1/4	M18x1.5	10	52	27	19
1D256-12-5	8	-05	7.9	5/16	M20x1.5	12	53	27	22
1D256-14-6	10	-06	9.5	3/8	M22x1.5	14	57	31	24
1D256-16-6	10	-06	9.5	3/8	M24x1.5	16	57	31	24
1D256-16-8	12	-08	12.7	1/2	M24x1.5	16	60	32	24
1D256-20-12	20	-12	19.0	3/4	M30x2	20	72	39	32

Material: Steel, surface protection according to DIN 50 961 Fe/Zn, special materials available upon request

13D56 – Metric Standpipe

Heavy Series

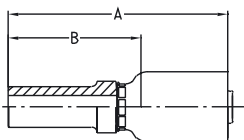

56 Series

Part No. #	DN size mm inch				Tube OD	A mm	B mm
13D56-8-3	5	-03	4.8	3/16	8	52	34
13D56-8-4	6	-04	6.4	1/4	8	59	34
13D56-10-4	6	-04	6.4	1/4	10	61	36
13D56-12-5	8	-05	7.9	5/16	12	63	37
13D56-12-6	10	-06	9.5	3/8	12	64	38
13D56-14-6	10	-06	9.5	3/8	14	67	41
13D56-16-8	12	-08	12.7	1/2	16	71	44
13D56-20-12	20	-12	19.0	3/4	20	84	50
13D56-25-12	20	-12	19.0	3/4	25	88	54

Material: Steel, surface protection according to DIN 50 961 Fe/Zn, special materials available upon request

Not recommended for new constructions. Please refer to end connections C9.



19256 – Sealing Head (60°) BSP Swivel Nut

56 Series

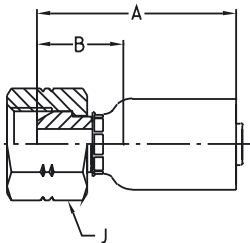

Part No. #	DN size mm inch				Connection Type		A mm	B mm	J mm
	mm	inch	Thread Size	Tube OD					
19256-4-3	5	-03	4.8	3/16	G 1/4	1/4	37	19	19
19256-2-4	6	-04	6.4	1/4	G 1/8	1/8	43	18	14
19256-4-4	6	-04	6.4	1/4	G 1/4	1/4	44	20	19
19256-6-4	6	-04	6.4	1/4	G 3/8	3/8	44	20	22
19256-4-5	8	-05	7.9	5/16	G 1/4	1/4	45	20	19
19256-6-5	8	-05	7.9	5/16	G 3/8	3/8	45	20	22
19256-6-6	10	-06	9.5	3/8	G 3/8	3/8	45	20	22
19256-8-6	12	-08	12.7	1/2	G 1/2	1/2	47	22	27
19256-8-8	12	-08	12.7	1/2	G 1/2	1/2	51	22	27
19256-10-8	12	-08	12.7	1/2	G 5/8	5/8	49	22	30
19256-12-12	20	-12	19.0	3/4	G 3/4	3/4	58	24	32
19256-16-16	25	-16	25.4	1	G 1	1	73	26	41

Material: Steel, surface protection according to DIN 50 961 Fe/Zn, special materials available upon request

1B156 – Sealing Head (60°) 45° Elbow BSP Swivel Nut

56 Series

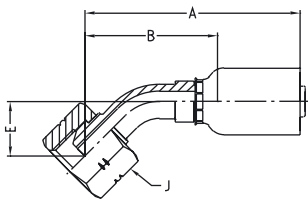

Part No. #	DN size mm inch				Connection Type		A mm	B mm	E mm	J mm
	mm	inch	Thread Size	Tube OD						
1B156-4-4	6	-04	6.4	1/4	G 1/4	1/4	62	38	16	19
1B156-6-5	8	-05	7.9	5/16	G 3/8	3/8	64	39	16	22
1B156-6-6	10	-06	9.5	3/8	G 3/8	3/8	66	41	17	22
1B156-8-8	12	-08	12.7	1/2	G 1/2	1/2	76	48	20	27
1B156-10-8	12	-08	12.7	1/2	G 5/8	5/8	75	48	19	30

Material: Steel, surface protection according to DIN 50 961 Fe/Zn, special materials available upon request

1B256 – Sealing Head (60°) 90° Elbow BSP Swivel Nut

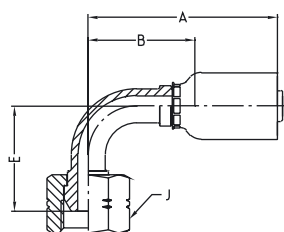

56 Series

Part No. #	DN size mm inch				Connection Type		A mm	B mm	E mm	J mm
	mm	inch	mm	inch	Thread Size	Tube OD				
1B256-4-3	5	-03	4.8	3/16	G 1/4	1/4	46	28	28	19
1B256-4-4	6	-04	6.4	1/4	G 1/4	1/4	53	29	28	19
1B256-6-5	8	-05	7.9	5/16	G 3/8	3/8	55	30	30	22
1B256-6-6	10	-06	9.5	3/8	G 3/8	3/8	58	33	33	22
1B256-8-8	12	-08	12.7	1/2	G 1/2	1/2	68	40	40	27
1B256-10-8	12	-08	12.7	1/2	G 5/8	5/8	68	41	38	30
1B256-12-12	20	-12	19.0	3/4	G 3/4	3/4	87	53	51	32
1B256-16-16	25	-16	25.4	1	G 1	1	115	67	63	41

Material: Steel, surface protection according to DIN 50 961 Fe/Zn, special materials available upon request

1B456 – BSP – Swivel Female 90° Compact Elbow

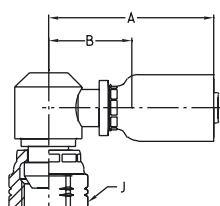

56 Series

Part No. #	DN size mm inch				Connection Type Thread Size	A mm	B mm	J mm
	mm	inch	mm	inch				
1B456-4-4	6	-04	6.4	1/4	G 1/4	47	23	19
1B456-6-6	10	-06	9.5	3/8	G 3/8	52	27	22
1B456-8-8	12	-08	12.7	1/2	G 1/2	58	31	27

Material: Steel, surface protection according to DIN 50 961 Fe/Zn, special materials available upon request

1U056 – Sealing Head (60°) BSP Swivel Nut

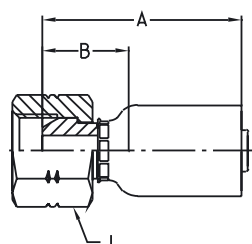

56 Series

Part No. #	Part No. #	DN size mm inch				Connection Type Thread Size	A mm	B mm	J mm
		mm	inch	mm	inch				
1U056-4-4	1U056-4-4 C2W	6	-04	6.4	1/4	G 1/4	44	20.0	19
1U056-6-4	1U056-6-4 C2W	6	-04	6.4	1/4	G 3/8	45	20.5	22

Material: Steel, surface protection according to DIN 50 961 Fe/Zn, C2W includes stainless steel nipple (material 1.4301)

1D956 – BSP Male DIN 3852 Shape A

56 Series

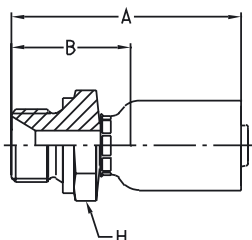

Part No. #	DN size mm inch				Connection Type		A mm	B mm	H mm
	mm	inch	mm	inch	Thread Size	Tube OD			
1D956-4-4	6	-04	6,4	1/4	G 1/4	1/4	52	27	19
1D956-6-5	8	-05	7,9	5/16	G 3/8	3/8	53	27	22
1D956-6-6	10	-06	9,5	3/8	G 3/8	3/8	53	28	22
1D956-8-8	12	-08	12,7	1/2	G 1/2	1/2	60	32	27
1D956-12-12	20	-12	19,0	3/4	G 3/4	3/4	75	42	32

Material: Steel, surface protection according to DIN 50 961 Fe/Zn, special materials available upon request

10156 – NPTF Male - 60° Cone

56 Series

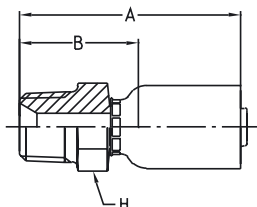

Part No. #	DN size mm inch				Connection Type		A mm	B mm	H mm
	mm	inch	mm	inch	Thread Size	Tube OD			
10156-2-3	5	-03	4.8	3/16	1/8 - 27NPTF	1/8	41	23	14
10156-4-3	5	-03	4.8	3/16	1/4 - 18NPTF	1/4	45	27	16
10156-6-3	5	-03	4.8	3/16	3/8 - 18NPTF	3/8	48	30	19
10156-2-4	6	-04	6.4	1/4	1/8 - 27NPTF	1/8	49	24	14
10156-4-4	6	-04	6.4	1/4	1/4 - 18NPTF	1/4	52	28	16
10156-6-4	6	-04	6.4	1/4	3/8 - 18NPTF	3/8	54	30	19
10156-4-5	8	-05	7.9	5/16	1/4 - 18NPTF	1/4	54	28	16
10156-6-5	8	-05	7.9	5/16	3/8 - 18NPTF	3/8	56	30	19
10156-4-6	10	-06	9.5	3/8	1/4 - 18NPTF	1/4	55	30	19
10156-6-6	10	-06	9.5	3/8	3/8 - 18NPTF	3/8	55	30	19
10156-8-6	10	-06	9.5	3/8	1/2 - 14NPTF	1/2	60	35	22
10156-6-8	12	-08	12.7	1/2	3/8 - 18NPTF	3/8	58	31	19
10156-8-8	12	-08	12.7	1/2	1/2 - 14NPTF	1/2	63	35	22
10156-12-12	20	-12	19.0	3/4	3/4 - 14NPTF	3/4	76	42	32

Material: Steel, surface protection according to DIN 50 961 Fe/Zn, special materials available upon request

10356 – JIC Male 37° Cone

56 Series

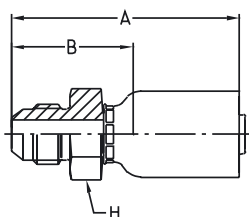

Part No. #	DN size mm inch				Connection Type		A mm	B mm	H mm
					Thread Size 	Tube OD 			
10356-4-3	5	-03	4.8	3/16	3/8 - 24UNF	1/4	45	27	14
10356-4-4	6	-04	6.4	1/4	7/16 - 20UNF	1/4	52	27	14
10356-5-4	6	-04	6.4	1/4	1/2 - 20UNF	5/16	52	27	14
10356-6-4	6	-04	6.4	1/4	1/2 - 20UNF	5/16	54	30	19
10356-5-5	8	-05	7.9	5/16	9/16 - 18UNF	3/8	53	27	14
10356-6-5	8	-05	7.9	5/16	9/16 - 18UNF	3/8	55	29	19
10356-6-6	10	-06	9.5	3/8	9/16 - 18UNF	3/8	55	30	19
10356-8-6	10	-06	9.5	3/8	3/4 - 16UNF	1/2	57	32	22
10356-8-8	12	-08	12.7	1/2	3/4 - 16UNF	1/2	61	32	22
10356-10-8	12	-08	12.7	1/2	7/8 - 14UNF	5/8	65	37	22

Material: Steel, surface protection according to DIN 50 961 Fe/Zn, special materials available upon request

10556 – UNF Male / O-Ring

56 Series

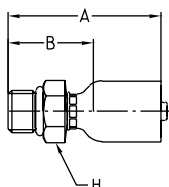

Part No. #	DN size mm inch				Connection Type		A mm	B mm	H mm
					Thread Size 	Tube OD 			
10556-4-3	5	-03	4.8	3/16	7/16 - 20UNF	1/4	40	22	14
10556-4-4	6	-04	6.4	1/4	7/16 - 20UNF	1/4	47	22	14
10556-5-4	6	-04	6.4	1/4	1/2 - 20UNF	5/16	47	23	17
10556-6-4	6	-04	6.4	1/4	9/16 - 18UNF	3/8	51	27	19
10556-4-5	8	-05	7.9	5/16	7/16 - 20UNF	1/4	48	22	14
10556-5-5	8	-05	7.9	5/16	1/2 - 20UNF	5/16	49	23	17
10556-6-6	10	-06	9.5	3/8	9/16 - 18UNF	3/8	52	26	19
10556-8-6	10	-06	9.5	3/8	3/4 - 16UNF	1/2	52	27	22
10556-8-8	12	-08	12.7	1/2	3/4 - 16UNF	1/2	55	28	22
10556-10-8	12	-08	12.7	1/2	7/8 - 14UNF	5/8	57	30	27

Material: Steel, surface protection according to DIN 50 961 Fe/Zn, special materials available upon request



10656 – JIC - 37° Cone UNF Swivel Nut

56 Series

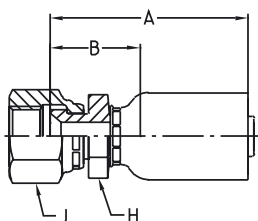

Part No. #	DN size		mm		inch		Connection Type			
	mm	inch	mm	inch	Thread Size	Tube OD	A mm	B mm	H mm	J mm
10656-4-3	5	-03	4.8	3/16	7/16 - 20UNF	1/4	36	19	12	17
10656-5-3	5	-03	4.8	3/16	1/2 - 20UNF	5/16	37	20	12	17
10656-4-4	6	-04	6.4	1/4	7/16 - 20UNF	1/4	44	19	14	17
10656-5-4	6	-04	6.4	1/4	1/2 - 20UNF	5/16	44	20	14	17
10656-6-4	6	-04	6.4	1/4	9/16 - 18UNF	3/8	45	20	14	19
10656-5-5	8	-05	7.9	5/16	1/2 - 20UNF	5/16	46	21	14	17
10656-6-5	8	-05	7.9	5/16	9/16 - 18UNF	3/8	47	21	17	19
10656-8-5	8	-05	7.9	5/16	3/4 - 16UNF	1/2	49	23	17	22
10656-6-6	10	-06	9.5	3/8	9/16 - 18UNF	3/8	47	22	17	19
10656-8-6	10	-06	9.5	3/8	3/4 - 16UNF	1/2	49	24	19	22
10656-6-8	12	-08	12.7	1/2	9/16 - 18UNF	3/8	52	25	22	19
10656-8-8	12	-08	12.7	1/2	3/4 - 16UNF	1/2	54	27	22	22
10656-10-8	12	-08	12.7	1/2	7/8 - 14UNF	5/8	54	26	24	27
10656-12-8	12	-08	12.7	1/2	1 1/16 - 12UNF	3/4	54	27	24	32
10656-12-10	16	-10	15.9	5/8	1 1/16 - 12UNF	3/4	63	31	27	32
10656-12-12	20	-12	19.0	3/4	1 1/16 - 12UNF	3/4	63	30	27	32
10656-16-16	25	-16	25.4	1	1 5/16 - 12UNF	1	82	34	32	41

Material: Steel, surface protection according to DIN 50 961 Fe/Zn, special materials available upon request

13756 – JIC - 37° Cone 45° Elbow UNF Swivel Nut

56 Series

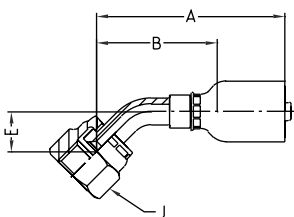





Part No. #	DN size		mm		inch		Connection Type			
	mm	inch	mm	inch	Thread Size	Tube OD	A mm	B mm	E mm	J mm
13756-4-3	5	-03	4.8	3/16	7/16 - 20UNF	1/4	49	32	11	17
13756-4-4	6	-04	6.4	1/4	7/16 - 20UNF	1/4	57	33	11	17
13756-5-4	6	-04	6.4	1/4	1/2 - 20UNF	5/16	58	33	11	17
13756-6-5	8	-05	7.9	5/16	9/16 - 18UNF	3/8	59	34	11	19
13756-6-6	10	-06	9.5	3/8	9/16 - 18UNF	3/8	60	36	11	19
13756-8-6	10	-06	9.5	3/8	3/4 - 16UNF	1/2	64	39	15	22
13756-8-8	12	-08	12.7	1/2	3/4 - 16UNF	1/2	69	42	14	22
13756-10-8	12	-08	12.7	1/2	7/8 - 14UNF	5/8	70	43	16	27

Material: Steel, surface protection according to DIN 50 961 Fe/Zn, special materials available upon request

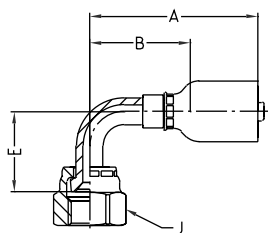
13956 – JIC - 37° Cone 90° Elbow UNF Swivel Nut

56 Series



Part No. #	DN size mm inch				Connection Type		A mm	B mm	E mm	J mm
					Thread Size 	Tube OD 				
13956-4-3	5	-03	4.8	3/16	7/16 - 20UNF	1/4	44	26	21.0	17
13956-4-4	6	-04	6.4	1/4	7/16 - 20UNF	1/4	53	29	21.0	17
13956-5-4	6	-04	6.4	1/4	1/2 - 20UNF	5/16	53	29	21.5	17
13956-6-4	6	-04	6.4	1/4	9/16 - 18UNF	3/8	53	29	22.0	19
13956-6-5	8	-05	7.9	5/16	9/16 - 18UNF	3/8	55	30	23.0	19
13956-6-6	10	-06	9.5	3/8	9/16 - 18UNF	3/8	56	31	23.0	19
13956-8-6	10	-06	9.5	3/8	3/4 - 16UNF	1/2	56	31	29.0	22
13956-8-8	12	-08	12.7	1/2	3/4 - 16UNF	1/2	63	37	29.0	22
13956-10-8	12	-08	12.7	1/2	7/8 - 14UNF	5/8	63	37	31.5	27
13956-12-12	20	-12	19.0	3/4	1 1/16 - 12UNF	3/4	87	53	46.0	32



Material: Steel, surface protection according to DIN 50 961 Fe/Zn, special materials available upon request

1JC56 – O-Lok® ORFS (Short Version) UNF Swivel Nut ISO 12151-1

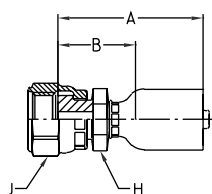

56 Series





Part No. #	DN size mm inch				Connection Type		A mm	B mm	H mm	J mm
					Thread Size 	Tube OD 				
1JC56-4-3	5	-03	4.8	3/16	9/16 - 18UNF	1/4	38	22	14	17
1JC56-4-4	6	-04	6.4	1/4	9/16 - 18UNF	1/4	45	22	14	17
1JC56-6-4	6	-04	6.4	1/4	11/16 - 16UNF	3/8	47	23	17	22
1JC56-4-5	8	-05	7.9	5/16	9/16 - 16UNF	1/4	46	22	14	17
1JC56-6-5	8	-05	7.9	5/16	11/16 - 16UNF	3/8	48	25	17	22
1JC56-6-6	10	-06	9.5	3/8	11/16 - 16UNF	3/8	48	25	17	22
1JC56-8-6	10	-06	9.5	3/8	13/16 - 16UNF	1/2	51	26	22	24
1JC56-8-8	12	-08	12.7	1/2	13/16 - 16UNF	1/2	54	28	22	24
1JC56-10-8	12	-08	12.7	1/2	1 - 14UNF	5/8	59	32	27	30

Material: Steel, surface protection according to DIN 50 961 Fe/Zn, special materials available upon request

1JS56 – O-Lok® ORFS UNF Swivel Nut ISO 12151-1

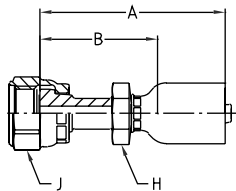
56 Series





Part No. #	DN size mm inch				Connection Type		A mm	B mm	H mm	J mm
					Thread Size	Tube OD				
1JS56-4-3	5	-03	4.8	3/16	9/16 - 18UNF	1/4	49	31	14	17
1JS56-4-4	6	-04	6.4	1/4	9/16 - 18UNF	1/4	56	31	14	17
1JS56-6-4	6	-04	6.4	1/4	11/16 - 16UNF	3/8	58	33	17	22
1JS56-4-5	8	-05	7.9	5/16	9/16 - 16UNF	1/4	57	31	14	17
1JS56-6-5	8	-05	7.9	5/16	11/16 - 16UNF	3/8	59	33	17	22
1JS56-6-6	10	-06	9.5	3/8	11/16 - 16UNF	3/8	59	33	17	22
1JS56-8-6	10	-06	9.5	3/8	13/16 - 16UNF	1/2	63	38	22	24
1JS56-8-8	12	-08	12.7	1/2	13/16 - 16UNF	1/2	66	39	22	24

Material: Steel, surface protection according to DIN 50 961 Fe/Zn, special materials available upon request

1JM56 – O-Lok® ORFS Male ISO 12151-1

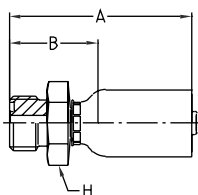
56 Series



Part No. #	DN size mm inch				Connection Type		A mm	B mm	H mm
					Thread Size	Tube OD			
1JM56-4-4	6	-04	6.4	1/4	9/16 - 18UNF	1/4	48	23	19
1JM56-6-6	10	-06	9.5	3/8	11/16 - 16UNF	3/8	51	25	22
1JM56-8-6	10	-06	9.5	3/8	13/16 - 16UNF	1/2	53	27	22

Material: Steel, surface protection according to DIN 50 961 Fe/Zn, special materials available upon request

1J756 – O-Lok® ORFS 45° Elbow

UNF Swivel Nut

ISO 12151-1

56 Series

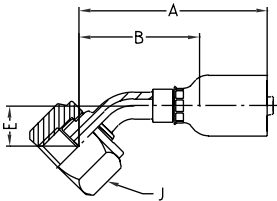

Part No. #	DN size mm inch				Connection Type		A mm	B mm	E mm	J mm
	mm	inch	Thread Size	Tube OD						
1J756-4-4	6	-04	6.4	1/4	9/16 - 18UNF	1/4	57	33	11	17
1J756-6-4	6	-04	6.4	1/4	11/16 - 16UNF	3/8	59	34	12	22
1J756-6-6	10	-06	9.5	3/8	11/16 - 16UNF	3/8	60	35	11	22
1J756-8-6	10	-06	9.5	3/8	13/16 - 16UNF	1/2	60	35	11	24
1J756-8-8	12	-08	12.7	1/2	13/16 - 16UNF	1/2	69	41	15	24

Material: Steel, surface protection according to DIN 50 961 Fe/Zn, special materials available upon request

1J956 – O-Lok® ORFS 90° Elbow

UNF Swivel Nut

ISO 12151-1

56 Series

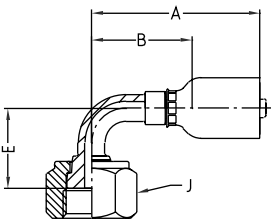

Part No. #	DN size mm inch				Connection Type		A mm	B mm	E mm	J mm
	mm	inch	Thread Size	Tube OD						
1J956-4-4	6	-04	6.4	1/4	9/16 - 18UNF	1/4	53	29	21	17
1J956-6-4	6	-04	6.4	1/4	11/16 - 16UNF	3/8	53	29	23	22
1J956-6-5	8	-05	7.9	5/16	11/16 - 16UNF	3/8	55	30	23	22
1J956-6-6	10	-06	9.5	3/8	11/16 - 16UNF	3/8	56	31	23	22
1J956-8-8	12	-08	12.7	1/2	13/16 - 16UNF	1/2	63	35	29	24

Material: Steel, surface protection according to DIN 50 961 Fe/Zn, special materials available upon request



1J156 – O-Lok® ORFS 90° Elbow (Long Drop Length) UNF Swivel Nut ISO 12151-1

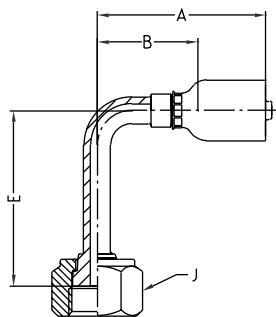

56 Series

Part No. #	DN size mm inch				Connection Type		A mm	B mm	E mm	J mm
	mm	inch	mm	inch	Thread Size	Tube OD				
1J156-4-4	6	-04	6.4	1/4	9/16 - 18UNF	1/4	53	29	46	17
1J156-6-6	10	-06	9.5	3/8	11/16 - 16UNF	3/8	56	31	54	22
1J156-8-6	10	-06	9.5	3/8	13/16 - 16UNF	1/2	56	31	64	24
1J156-8-8	12	-08	12.7	1/2	13/16 - 16UNF	1/2	63	35	64	24

Material: Steel, surface protection according to DIN 50 961 Fe/Zn, special materials available upon request

14956 – Banjo Union DIN 7642

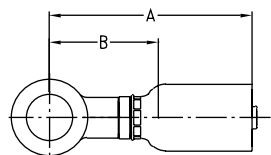

56 Series

Part No. #	DN size mm inch				Tube OD	A mm	B mm
14956-10-4	6	-04	6.4	1/4	10	51	27
14956-12-4	6	-04	6.4	1/4	12	53	29
14956-14-4	6	-04	6.4	1/4	14	56	32
14956-12-5	8	-05	7.9	5/16	12	55	30
14956-14-5	8	-05	7.9	5/16	14	57	32
14956-12-6	10	-06	9.5	3/8	12	55	31

Material: Steel, surface protection according to DIN 50 961 Fe/Zn, special materials available upon request